

SD1150 OVERVIEW

The SD1150 is a dual-channel, 16-bit, analog-to-digital converter (ADC) supporting sampling rates up to 40MSps. The device uses a multistage pipeline architecture to achieve high signal-to-noise ratio (SNR) and linearity, over wide input signal bandwidth. The SD1150 can be set to operate using either CMOS or LVDS output interface. Programming for configuration and control is accomplished using a 3-wire SPI-compatible serial bus. The digital output data can be programmed to be delivered in offset binary, twos complement format, or gray code.

The device includes a DSP block that features decimation, digital down conversion (DDC), and IQ mismatch correction.

FEATURES

- SNR: 75.6dBFS at $f_{IN} = 30.2\text{MHz}$ and $f_S = 40\text{MSps}$
- SFDR: 91.0dBc at $f_{IN} = 30.2\text{MHz}$ and $f_S = 40\text{MSps}$
- -149.5dBFS/Hz input-noise at $f_{IN} = 30.2\text{MHz}$ and $f_S = 40\text{MSps}$
- 2.0V nominal input
- Typical power consumption: 310mW at 40MSps
- Integer 1-to-8 input clock divider (320MHz maximum input rate)
- Sample rates of up to 40MSps
- 1.8V analog supply voltage
- LVDS (ANSI-644 levels) outputs
- Internal ADC voltage reference
- ADC clock duty cycle correction
- Serial port control
- Decimation by 2, 4
- Digital Down-Conversion
- IQ Mismatch Correction
- Energy saving power-down modes

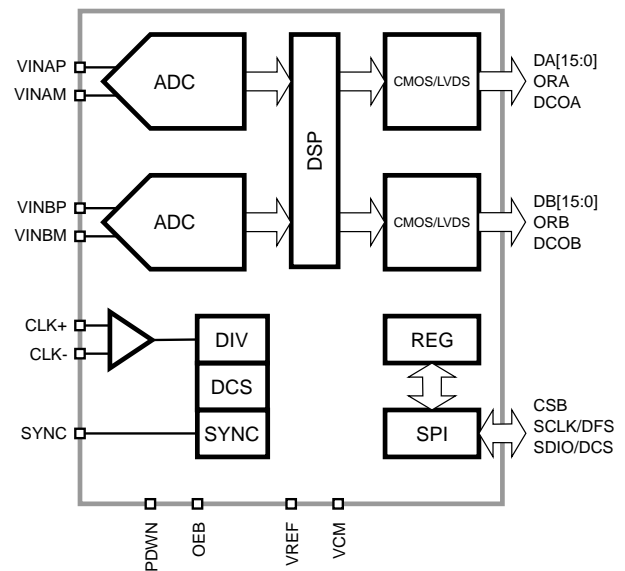

Figure 1: SD1150 Functional Block Diagram.

APPLICATIONS

- Communications
- General-purpose software radios
- I/Q demodulation systems
- Diversity radio systems
- Smart antenna systems
- Multimode digital receivers
- Ultrasound equipment
- Radar/LiDAR applications
- Test and Measurement

Table of Contents

SPECIFICATIONS	1
DC Specifications	1
AC Specifications	2
Digital Specification	3
Switching Specifications	5
Output Modes	6
Output Timing Control	6
LVDS→CMOS Conversion	7
ABSOLUTE MAXIMUM RATINGS	8
PACKAGE	9
TYPICAL PERFORMANCE CHARACTERISTICS	13
EQUIVALENT CIRCUITS	15
THEORY OF OPERATION	17
ADC Architecture	17
Stand-by and Power-Down Modes	18
Commonly Used Functions	19
DSP	20
Input MUX	20
Delay, Offset, and Gain	20
IQ Phase Correction	20
Digital Down Converter (DDC)	20
Decimator	21
Digital IOs	23
SERIAL PORT INTERFACE	25
OUTPUT MODE	27
Data Scrambler	27
Alternate Bit Polarity	27
Output Test Modes	27
CONTROL REGISTERS	29
ADC BRING-UP	33
ORDERING INFORMATION	34
PACKAGE DRAWING	35
APPENDIX A: Register Map	36
0x400 - CHIP_TOP	36
0xF00 - ADC_DUAL	40
0xDC0 - ADC A	42
0xCC1 - ADC B	44
0x800 - ADC_DSP	45
REVISION HISTORY	50

SPECIFICATIONS

DC Specifications

At $T_A = 25^\circ\text{C}$, $V_{AVDD} = 1.8\text{V}$, $V_{DRVDD} = 1.8\text{V}$, $F_{CLK} = 40\text{MHz}$, $A_{IN} = -1\text{dBFS}$, differential AC-coupled external clock source, LVDS mode, unless otherwise noted.

Table 1. DC Specifications.

PARAMETER	TEMP	MIN	TYP	MAX	UNIT
Resolution			16		bits
Accuracy					
Offset Error	Full	-0.50		0.50	%FSR
Gain Error	Full	0.00		0.00	%FSR
DNL	Full			±2.5	LSB
INL	Full			±8.0	LSB
Matching					
Offset Error	25°C	-0.80		0.80	%FSR
Gain Error	25°C	-0.40		0.40	%FSR
Temperature Drift					
Offset Error	Full		±0.5		ppm/°C
Gain Error	Full		80.0		ppm/°C
Internal Voltage Reference					
Output Voltage	Full	1.02		1.07	V
External Voltage Reference					
Range	Full	0.90		1.07	V
Input Referred Noise					
$V_{REF} = 1.0\text{V}$	25°C		3.48		LSB(rms)
Analog Input					
Input Span, $V_{REF} = 1.0\text{V}$	Full		2.0		V
Input Capacitance	Full		6.0		pF
Input Resistance	Full		2.0		kΩ
Input Common-Mode Voltage	Full		0.70		V
Input Common-Mode Range	Full	0.62		0.93	V
VCM Voltage	Full		0.68		V
VCM Current Capability	Full		100		μA
Reference Input Resistance	Full		50		kΩ
Power Supply					
V_{AVDD}	Full	1.7	1.8	1.9	V
V_{DRVDD}	Full	1.7	1.8	1.9	V
$I_{AVDD} @ 1.8\text{V}$	Full		159	205	mA
$I_{DRVDD} @ 1.8\text{V (CMOS)}$	Full		10	12	mA
$I_{DRVDD} @ 1.8\text{V (LVDS)}$	Full		50	67	mA
Power Consumption					
Sine Wave Input (CMOS)	Full		310		mW
Sine Wave Input (LVDS)	Full		385		mW
Stand-by ¹	Full		60		mW
Power Down	Full		10.0		mW

¹ Stand-by power is measured with a sinewave input and active clock.

AC Specifications

At $T_A = 25^\circ\text{C}$, $V_{AVDD} = 1.8\text{V}$, $V_{DRVDD} = 1.8\text{V}$, $F_{CLK} = 40\text{MHz}$, $A_{IN} = -1\text{dBFS}$, differential AC-coupled external clock source, High-Performance Calibration Mode enabled, LVDS mode, unless otherwise noted.

Table 2. AC Performance Specifications.

PARAMETER	TEMP	MIN	TYP	MAX	UNIT
Signal-to-Noise Ratio (SNR)					
$f_{IN} = 6.55\text{MHz}$	25°C		75.9		dBFS
$f_{IN} = 30.2\text{MHz}$	25°C		75.6		dBFS
	Full	74.5			dBFS
$f_{IN} = 70.2\text{MHz}$	25°C		74.8		dBFS
$f_{IN} = 220\text{MHz}$	25°C		70.7		dBFS
Signal-to-Noise and Distortion Ratio (SNDR)					
$f_{IN} = 6.55\text{MHz}$	25°C		75.7		dBFS
$f_{IN} = 30.2\text{MHz}$	25°C		75.4		dBFS
	Full	74.0			dBFS
$f_{IN} = 70.2\text{MHz}$	25°C		74.6		dBFS
$f_{IN} = 220\text{MHz}$	25°C		70.4		dBFS
Effective Number of Bits (ENOB)					
$f_{IN} = 6.55\text{MHz}$	25°C		12.3		bits
$f_{IN} = 30.2\text{MHz}$	25°C		12.2		bits
$f_{IN} = 70.2\text{MHz}$	25°C		12.1		bits
$f_{IN} = 220\text{MHz}$	25°C		11.4		bits
Worst 2 nd or 3 rd Harmonic Power					
$f_{IN} = 6.55\text{MHz}$	25°C		-91.0		dBc
$f_{IN} = 30.2\text{MHz}$	25°C		-92.0	-85.0	dBc
$f_{IN} = 70.2\text{MHz}$	25°C		-91.0		dBc
$f_{IN} = 220\text{MHz}$	25°C		-83.0		dBc
Worst Non-Harmonic Power					
$f_{IN} = 6.55\text{MHz}$	25°C		-96.0		dBc
$f_{IN} = 30.2\text{MHz}$	25°C		-92.0	-86.0	dBc
$f_{IN} = 70.2\text{MHz}$	25°C		-92.0		dBc
$f_{IN} = 220\text{MHz}$	25°C		-84.0		dBc
Spurious-Free Dynamic Range ¹ (SFDR)					
$f_{IN} = 6.55\text{MHz}$	25°C		91.0		dBc
$f_{IN} = 30.2\text{MHz}$	25°C		91.0		dBc
	Full	84.0			dBc
$f_{IN} = 70.2\text{MHz}$	25°C		90.0		dBc
$f_{IN} = 220\text{MHz}$	25°C		82.0		dBc
Two-Tone SFDR					
$f_{IN1} = 29.1\text{MHz}$, $f_{IN2} = 30.6\text{MHz}$	25°C		96.5		dBc
Crosstalk ²					
	25°C		-105.0		dBc
Analog Input Bandwidth					
	Full		650.0		MHz

¹ SNR, SNDR and SFDR exclude the DC and $f_s/2$ bins.

² Crosstalk is measured at 100MHz with -1.0dBFS on one channel and no input on the alternate channel.

Digital Specification

$V_{AVDD} = 1.8V$, $V_{DRVDD} = 1.8V$, $F_{CLK} = 40MHz$, $A_{IN} = -1dBFS$, differential AC-coupled external clock source, DCS disabled, unless otherwise noted.

Table 3. Differential Clock Input.

PARAMETER	TEMP	MIN	TYP	MAX	UNIT
Logic Compliance	Full	CMOS/LVDS/LVPECL			
Internal Common-Mode Bias	Full		0.9		V
Differential Input Voltage	Full	0.3		1.2	V_{p-p}
Input Voltage Range	Full	$V_{AGND}-0.3$		$V_{AVDD}+0.2$	V
Input Common-Mode Range	Full	0.75		1.05	V
High Level Input Current	Full	-10		10	μA
Low Level Input Current	Full	-10		10	μA
Input Capacitance	Full		1.7		pF
Input Resistance	Full		6.0		k Ω

Table 4. SYNC Input.

PARAMETER	TEMP	MIN	TYP	MAX	UNIT
Logic Compliance	Full	CMOS			
Input Voltage Range	Full	V_{AGND}		V_{AVDD}	V
High Level Input Voltage	Full	1.22		V_{AVDD}	V
Low Level Input Voltage	Full	V_{AGND}		0.50	V
High Level Input Current	Full	-1		1	μA
Low Level Input Current	Full	-1		1	μA
Input Capacitance	Full		1.5		pF
Input Resistance	Full		100		k Ω

Table 5. CSB Input.

PARAMETER	TEMP	MIN	TYP	MAX	UNIT
High Level Input Voltage	Full	1.22			V
Low Level Input Voltage	Full			0.6	V
High Level Input Current	Full	-1		1	μA
Low Level Input Current	Full	-1		1	μA
Input Capacitance	Full		1.5		pF
Input Resistance	Full		100		k Ω

Table 6. SCLK/DFS Input.

PARAMETER	TEMP	MIN	TYP	MAX	UNIT
High Level Input Voltage	Full	1.22			V
Low Level Input Voltage	Full			0.6	V
High Level Input Current	Full	-1		1	μA
Low Level Input Current	Full	-1		1	μA
Input Capacitance	Full		1.5		pF
Input Resistance	Full		100		k Ω

Table 7. SDIO/DCS Input.

PARAMETER	TEMP	MIN	TYP	MAX	UNIT
High Level Input Voltage	Full	1.22			V
Low Level Input Voltage	Full			0.6	V
High Level Input Current	Full	-1		1	μ A
Low Level Input Current	Full	-1		1	μ A
Input Capacitance	Full		1.5		pF
Input Resistance	Full		100		k Ω

Table 8. OEB Input.

PARAMETER	TEMP	MIN	TYP	MAX	UNIT
High Level Input Voltage	Full	1.22			V
Low Level Input Voltage	Full			0.6	V
High Level Input Current	Full	-1		1	μ A
Low Level Input Current	Full	-1		1	μ A
Input Capacitance	Full		1.5		pF
Input Resistance	Full		100		k Ω

Table 9. PDWN Input.

PARAMETER	TEMP	MIN	TYP	MAX	UNIT
High Level Input Voltage	Full	1.22			V
Low Level Input Voltage	Full			0.6	V
Pull-down Current @1.8V	Full			90	μ A
Input Capacitance	Full		1.5		pF
Input Resistance	Full		28		k Ω

Table 10. CMOS Outputs (DATA and OR).

PARAMETER	TEMP	MIN	TYP	MAX	UNIT
High Level Output Voltage @50 μ A	Full	1.77			V
High Level Output Voltage @0.5mA	Full	1.75			V
Low Level Output Voltage @50 μ A	Full			0.05	V
Low Level Output Voltage @1.6mA	Full			0.10	V

Table 11. LVDS Outputs (DATA and OR).

PARAMETER	TEMP	MIN	TYP	MAX	UNIT
Differential Output Voltage (V_{OD}), ANSI Mode	Full	250	300	450	mV
Output Offset Voltage (V_{OS}), ANSI Mode	Full	1.10	1.13	1.30	V
Differential Output Voltage (V_{OD}), Reduced Swing	Full	150	220	285	mV
Output Offset Voltage (V_{OS}), Reduced Swing	Full	1.10	1.22	1.30	V

Switching Specifications

$V_{AVDD} = 1.8V$, $V_{DRVDD} = 1.8V$, $F_{CLK} = 40MHz$, $A_{IN} = -1dBFS$, differential AC-coupled sine wave external clock source, DCS enabled, unless otherwise noted.

Table 12. Clock Input Timing.

PARAMETER	TEMP	MIN	TYP	MAX	UNIT
Input Clock Rate	Full			320	MHz
Conversion Rate (after clock divider)	Full	3.0		40.0	MHz
<i>CLK Pulse Width High (t_{CH})</i>					
Divide-by-1 Mode, DCS Enabled	Full	1.5			ns
Divide-by-1 Mode, DCS Disabled	Full	11.0	12.5	14.0	ns
Divide-by-2 Mode Through Divide-by-8 Mode	Full	1.5			ns
Aperture Delay (t_A)	Full		0.5		ns
Aperture Uncertainty (Jitter, t_J)	Full		140.0		fs

Table 13. SYNC Timing Requirements.

PARAMETER	MIN	TYP	MAX	UNIT
Set-Up Time ($t_{S,SYNC}$)		0.35		ns
Hold Time ($t_{H,SYNC}$)		0.35		ns

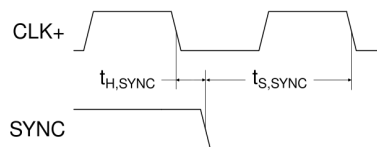

Figure 2: SYNC Input Timing.

Table 14. Data Output.

PARAMETER	TEMP	MIN	TYP	MAX	UNIT
<i>CMOS Mode</i>					
Data Propagation Delay (t_{PD})	Full		6.0		ns
DCO Propagation Delay (t_{DCO})	Full		7.0		ns
DCO to Data Skew (t_{SKEW})	Full	-1.1	-0.4	0.2	ns
Pipeline Delay (Latency, L)	Full		35.0		Cycles
<i>LVDS Mode</i>					
Data Propagation Delay (t_{PD})	Full		8.0		ns
DCO Propagation Delay (t_{DCO})	Full		7.7		ns
DCO to Data Skew (t_{SKEW})	Full	-1.1	-0.4	0.2	ns
Pipeline Delay (Latency, L) Channel A/Channel B	Full		32/32.5		Cycles
Wake-Up Time (from sleep)	Full		5.0		μs
Wake-Up Time (from power down)	Full		500.0		μs
Out-of-Range Recovery Time	Full		3		Cycles

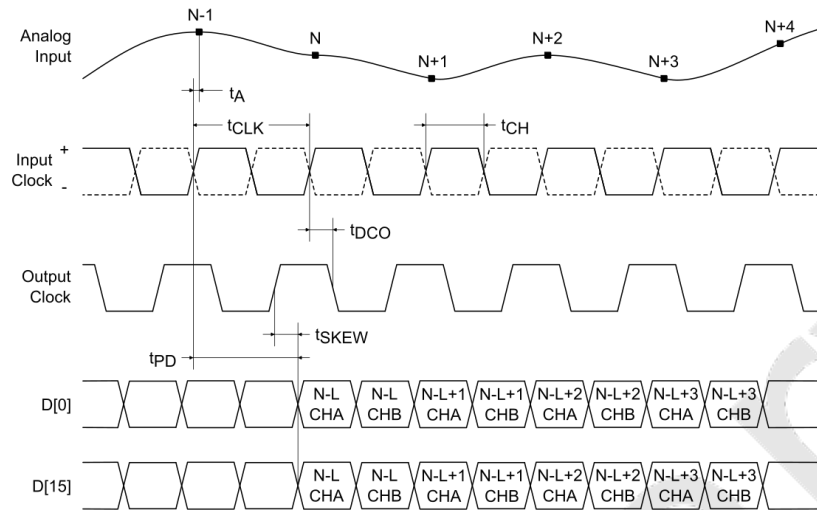

Figure 3: Parallel LVDS Output Mode Timing.

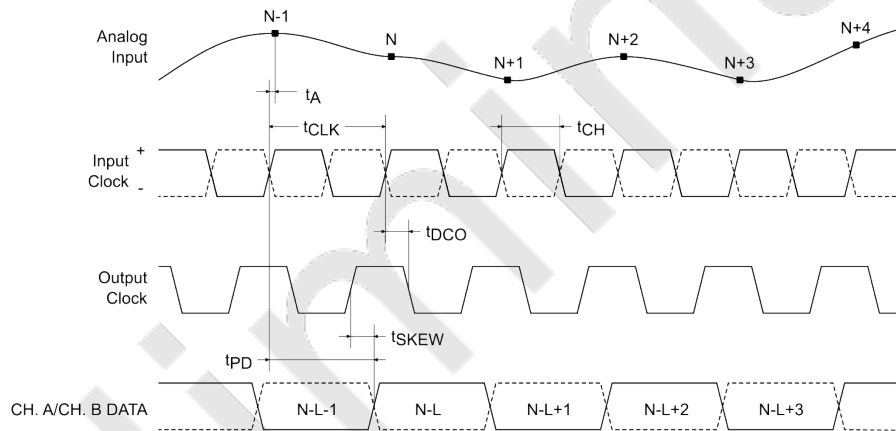

Figure 4: Parallel CMOS Output Mode Timing.

Output Modes

The SD1150 supports both CMOS and LVDS interfaces. Two LVDS samples are sent out every clock cycle using both the rising and the falling edge of the output clock. In interleaved parallel mode, the two ADCs share the full set of output pins. The first half-cycle contains ADC A data and the second ADC B data. In multiplexed mode, each ADC has its dedicated set of output pins and the data is sent out even numbered bits on the first half-cycle and the odd bits on the second. Register *0x465*, bits [2:0], control the interleaving/multiplexing (see register description for details). The ADC B overrange bit is not available in channel multiplexed mode, for the LVDS interface.

Output Timing Control

Data delay control, bits [8:5], in register *0x473*, can be used to move the CMOS data relative to output clock. Bit [9] inverts the internal clock sending the data out. Bits [13:10], in register *0x473*, control the output clock delay relative to output data, while bit [14] inverts the clock. The delay step size is about 250ps.

Data delay control is not available in interleaved or multiplexed output mode.

Driving long traces or large load capacitance with CMOS output produces voltage ripple in the digital IO supply and ground,

which may couple on chip to the sensitive analog circuits in the ADC and degrade the performance. This effect can be reduced by using an external buffer IC. The use of LVDS output interface largely eliminates issues with IO supply noise.

Due to the close proximity of the ADC_B LSB pin to the clock input pins, there is potential for noise coupling, which can degrade jitter performance. To mitigate this, the PCB layout should ensure that traces to these pins are routed separately, with a grounded shield placed between them. Jitter impact depends strongly on how data transitions align with sampling clock edges. Data delay control can be used to move the CMOS data transitions away from sensitive sampling clock edge.

LVDS→CMOS Conversion

The output interface can be converted to CMOS using the register writes in Table 15, where each IO pad is programmed to a CMOS driver.

Table 15. Output Mode Conversion (LVDS→CMOS).

Register	Value	Register	Value	Register	Value	Register	Value
0x401	0xc3	0x403	0xe1	0x405	0x4e0	0x407	0x4e0
0x409	0x8e0	0x40b	0x8e0	0x40d	0x4e0	0x40f	0x4e0
0x411	0x4e0	0x413	0x4e0	0x415	0x8e0	0x417	0x8e0
0x419	0x4e0	0x41b	0x4e0	0x41d	0x8e0	0x41f	0x8e0
0x421	0x8e0	0x423	0x8e0	0x425	0x4e0	0x427	0x10e0
0x429	0x8e0	0x42b	0x4e0	0x42d	0x8e0	0x42f	0x8e0
0x431	0x8e0	0x433	0x8e0	0x435	0xce0	0x437	0xce0
0x439	0x4e0	0x43b	0xce0	0x43d	0xce0	0x43f	0xce0
0x441	0x4e0	0x443	0x4e0	0x445	0x4e0	0x447	0x4e0
0x449	0x8e0	0x44b	0x8e0	0x44d	0xc3	0x44f	0xc3
0x451	0xc3	0x453	0xc3	0x466 bit[0]	0x0	0x466 bit[2]	0x0

ABSOLUTE MAXIMUM RATINGS

Table 16. Absolute Maximum Ratings ($T_A = 25^\circ\text{C}$, unless otherwise specified).

Parameter	Symbol	Conditions	Min	Max	Units
AVDD	V_{AVDD}	Relative to AGND	-0.3	2.0	V
DRVDD	V_{DRVDD}	Relative to AGND	-0.3	2.0	V
VINAP/VINBP, VINAM/VINBM		Relative to AGND	-0.3	2.0	V
CLK+, CLK-		Relative to AGND	-0.3	2.0	V
SYNC		Relative to AGND	-0.3	2.0	V
VCM		Relative to AGND	-0.3	2.0	V
VREF		Relative to AGND	-0.3	2.0	V
CSB		Relative to AGND	-0.3	2.0	V
SCLK/DFS		Relative to AGND	-0.3	2.0	V
SDIO/DCS		Relative to AGND	-0.3	2.0	V
OEB		Relative to AGND	-0.3	2.0	V
PDWN		Relative to AGND	-0.3	2.0	V
DA0, ..., DA15 DB0, ..., DB15		Relative to AGND	-0.3	2.0	V
DCO+, DCO-		Relative to AGND	-0.3	2.0	V
Operating Temperature Range (Ambient)			-40	85	°C
Maximum Junction Temperature Under Bias				125	
Storage Temperature Range (Ambient)			-65	150	

Notes:

- Stresses beyond those listed under Table 16 may cause permanent damage to the device. These are stress ratings only and functional operation of the device at these or any other conditions beyond those indicated under recommended operating conditions is not implied. Exposure to absolute-maximum-rated conditions for extended periods may affect device reliability.

ESD CAUTION.

	<p>Electrostatic Discharge Sensitive Device.</p> <p>Proper ESD precautions should be observed to prevent performance degradation or loss of functionality.</p>
---	---

PACKAGE

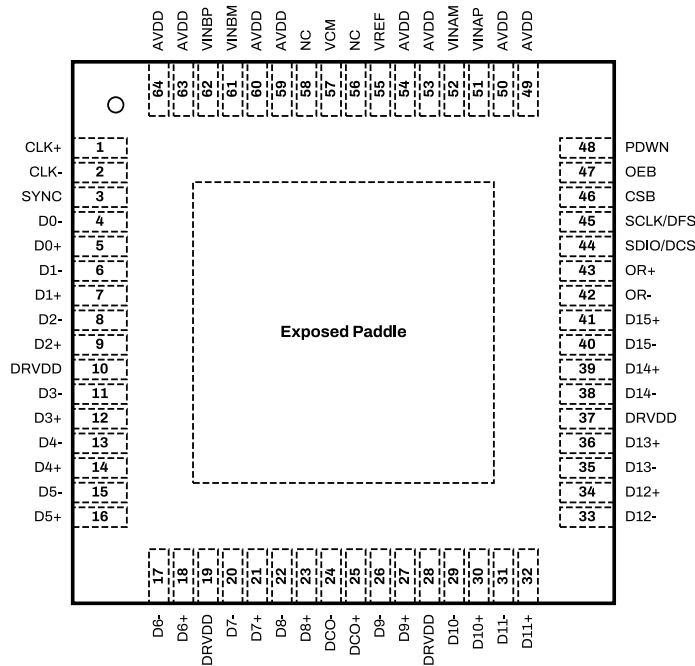

Figure 5: SD1150 Package Top View for Parallel LVDS Configuration.

1. The exposed thermal pad on the bottom of the package provides the analog ground for the part and must be connected for proper operation.

Table 17. Pin Descriptions for Parallel LVDS Configuration.

Number	Name	Type	Comment
0	AGND	Ground	Exposed Paddle, Analog Ground.
1	CLK+	Input	ADC Clock Input (Plus).
2	CLK-	Input	ADC Clock Input (Minus).
3	SYNC	Input	Digital Synchronization Pin.
4	D0-	Output	Channel A/Channel B LVDS Output Data 0 (Minus).
5	D0+	Output	Channel A/Channel B LVDS Output Data 0 (Plus).
6	D1-	Output	Channel A/Channel B LVDS Output Data 1 (Minus).
7	D1+	Output	Channel A/Channel B LVDS Output Data 1 (Plus).
8	D2-	Output	Channel A/Channel B LVDS Output Data 2 (Minus).
9	D2+	Output	Channel A/Channel B LVDS Output Data 2 (Plus).
10, 19, 28, 37	DRVDD	Power	Digital I/O Supply.
11	D3-	Output	Channel A/Channel B LVDS Output Data 3 (Minus).
12	D3+	Output	Channel A/Channel B LVDS Output Data 3 (Plus).
13	D4-	Output	Channel A/Channel B LVDS Output Data 4 (Minus).
14	D4+	Output	Channel A/Channel B LVDS Output Data 4 (Plus).
15	D5-	Output	Channel A/Channel B LVDS Output Data 5 (Minus).
16	D5+	Output	Channel A/Channel B LVDS Output Data 5 (Plus).

Number	Name	Type	Comment
17	D6-	Output	Channel A/Channel B LVDS Output Data 6 (Minus).
18	D6+	Output	Channel A/Channel B LVDS Output Data 6 (Plus).
20	D7-	Output	Channel A/Channel B LVDS Output Data 7 (Minus).
21	D7+	Output	Channel A/Channel B LVDS Output Data 7 (Plus).
22	D8-	Output	Channel A/Channel B LVDS Output Data 8 (Minus).
23	D8+	Output	Channel A/Channel B LVDS Output Data 8 (Plus).
24	DCO-	Output	LVDS Data Clock Output (Minus).
25	DCO+	Output	LVDS Data Clock Output (Plus).
26	D9-	Output	Channel A/Channel B LVDS Output Data 9 (Minus).
27	D9+	Output	Channel A/Channel B LVDS Output Data 9 (Plus).
29	D10-	Output	Channel A/Channel B LVDS Output Data 10 (Minus).
30	D10+	Output	Channel A/Channel B LVDS Output Data 10 (Plus).
31	D11-	Output	Channel A/Channel B LVDS Output Data 11 (Minus).
32	D11+	Output	Channel A/Channel B LVDS Output Data 11 (Plus).
33	D12-	Output	Channel A/Channel B LVDS Output Data 12 (Minus).
34	D12+	Output	Channel A/Channel B LVDS Output Data 12 (Plus).
35	D13-	Output	Channel A/Channel B LVDS Output Data 13 (Minus).
36	D13+	Output	Channel A/Channel B LVDS Output Data 13 (Plus).
38	D14-	Output	Channel A/Channel B LVDS Output Data 14 (Minus).
39	D14+	Output	Channel A/Channel B LVDS Output Data 14 (Plus).
40	D15-	Output	Channel A/Channel B LVDS Output Data 15 (Minus).
41	D15+	Output	Channel A/Channel B LVDS Output Data 15 (Plus).
42	OR-	Output	Channel A/Channel B LVDS Overrange (Minus).
43	OR+	Output	Channel A/Channel B LVDS Overrange (Plus).
44	SDIO/DCS	InOut	SPI Serial Data I/O/Duty Cycle Stabilizer Pin in External Pin Mode.
45	SCLK/DFS	Input	SPI Serial Clock/Data Format Select Pin in External Pin Mode.
46	CSB	Input	SPI Chip Select (Active Low).
47	OEB	Input	Output Enable Input (Active low).
48	PDWN	Input	Power-Down Input (Active High). The operation of this pin depends on the SPI mode and can be configured as power-down or stand-by.
49, 50, 53, 54, 59, 60, 63, 64	AVDD	Power	Analog Power Supply (1.8 V Nominal).
51	VINAP	Input	Differential Analog Input Pin (Plus) for Channel A.
52	VINAM	Input	Differential Analog Input Pin (Minus) for Channel A.
55	VREF	InOut	Voltage Reference Input/Output.
56, 58	NC		Do not connect.
57	VCM	Output	This pin outputs the common-mode voltage that can be used externally to bias the analog input pins.
61	VINBM	Input	Differential Analog Input Pin (Minus) for Channel B.
62	VINBP	Input	Differential Analog Input Pin (Plus) for Channel B.

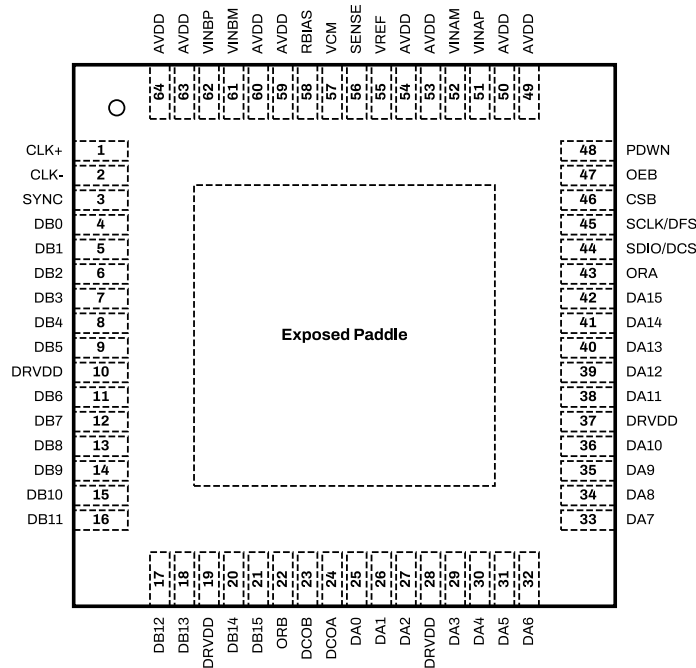

Figure 6: SD1150 Package Top View for Parallel CMOS Configuration.

1. The exposed thermal pad on the bottom of the package provides the analog ground for the part and must be connected for proper operation.

Table 18. Pin Descriptions for Parallel CMOS Configuration.

Number	Name	Type	Comment
0	AGND	Ground	Exposed Paddle, Analog Ground.
1	CLK+	Input	ADC Clock Input (Plus).
2	CLK-	Input	ADC Clock Input (Minus).
3	SYNC	Input	Digital Synchronization Pin.
4	DB0	Output	Channel B CMOS Output Data 0 (LSB).
5	DB1	Output	Channel B CMOS Output Data 1.
6	DB2	Output	Channel B CMOS Output Data 2.
7	DB3	Output	Channel B CMOS Output Data 3.
8	DB4	Output	Channel B CMOS Output Data 4.
9	DB5	Output	Channel B CMOS Output Data 5.
10, 19, 28, 37	DRVDD	Power	Digital I/O Supply.
11	DB6	Output	Channel B CMOS Output Data 6.
12	DB7	Output	Channel B CMOS Output Data 7.
13	DB8	Output	Channel B CMOS Output Data 8.
14	DB9	Output	Channel B CMOS Output Data 9.
15	DB10	Output	Channel B CMOS Output Data 10.
16	DB11	Output	Channel B CMOS Output Data 11.
17	DB12	Output	Channel B CMOS Output Data 12.
18	DB13	Output	Channel B CMOS Output Data 13.

Number	Name	Type	Comment
20	DB14	Output	Channel B CMOS Output Data 14.
21	DB15	Output	Channel B CMOS Output Data 15.
22	ORB	Output	Channel B Overrange Output.
23	DCOB	Output	Channel B Data Clock Output.
24	DCOA	Output	Channel A Data Clock Output.
25	DA0	Output	Channel A CMOS Output Data 0 (LSB).
26	DA1	Output	Channel A CMOS Output Data 1.
27	DA2	Output	Channel A CMOS Output Data 2.
29	DA3	Output	Channel A CMOS Output Data 3.
30	DA4	Output	Channel A CMOS Output Data 4.
31	DA5	Output	Channel A CMOS Output Data 5.
32	DA6	Output	Channel A CMOS Output Data 6.
33	DA7	Output	Channel A CMOS Output Data 7.
34	DA8	Output	Channel A CMOS Output Data 8.
35	DA9	Output	Channel A CMOS Output Data 9.
36	DA10	Output	Channel A CMOS Output Data 10.
38	DA11	Output	Channel A CMOS Output Data 11.
39	DA12	Output	Channel A CMOS Output Data 12.
40	DA13	Output	Channel A CMOS Output Data 13.
41	DA14	Output	Channel A CMOS Output Data 14.
42	DA15	Output	Channel A CMOS Output Data 15.
43	ORA	Output	Channel A Overrange Output.
44	SDIO/DCS	InOut	SPI Serial Data I/O/Duty Cycle Stabilizer Pin in External Pin Mode.
45	SCLK/DFS	Input	SPI Serial Clock/Data Format Select Pin in External Pin Mode.
46	CSB	Input	SPI Chip Select (Active Low).
47	OEB	Input	Output Enable Input (Active low).
48	PDWN	Input	Power-Down Input (Active High). The operation of this pin depends on the SPI mode and can be configured as power-down or stand-by.
49, 50, 53, 54, 59, 60, 63, 64	AVDD	Power	Analog Power Supply (1.8 V Nominal).
51	VINAP	Input	Differential Analog Input Pin (Plus) for Channel A.
52	VINAM	Input	Differential Analog Input Pin (Minus) for Channel A.
55	VREF	InOut	Voltage Reference Input/Output.
56	SENSE	Input	Reference Programming Pin.
57	VCM	Output	This pin outputs the common-mode voltage that can be used externally to bias the analog input pins.
58	RBIAS	InOut	External Reference Bias Resistor. Connect to 30 kΩ (1% tolerance) resistor to ground.
61	VINBM	Input	Differential Analog Input Pin (Minus) for Channel B.
62	VINBP	Input	Differential Analog Input Pin (Plus) for Channel B.

TYPICAL PERFORMANCE CHARACTERISTICS

At $T_A = 25^\circ\text{C}$, $V_{AVDD} = 1.8\text{V}$, $V_{DRVDD} = 1.8\text{V}$, $F_{CLK} = 40\text{MHz}$, $A_{IN} = -1\text{dBFS}$, differential AC-coupled clock source, High-Performance Calibration Mode enabled, LVDS mode, unless otherwise noted.

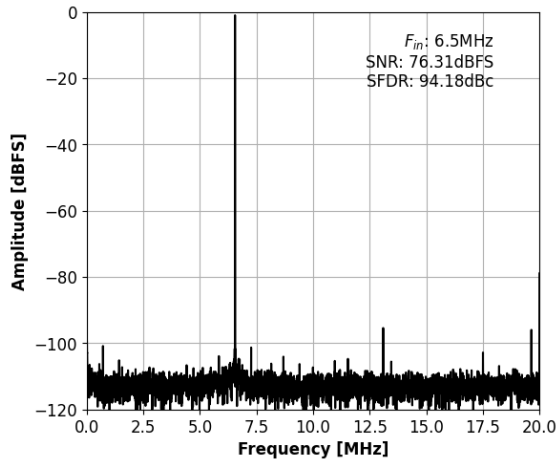

Figure 7: Single-Tone FFT with $f_{IN}=6.55\text{MHz}$.

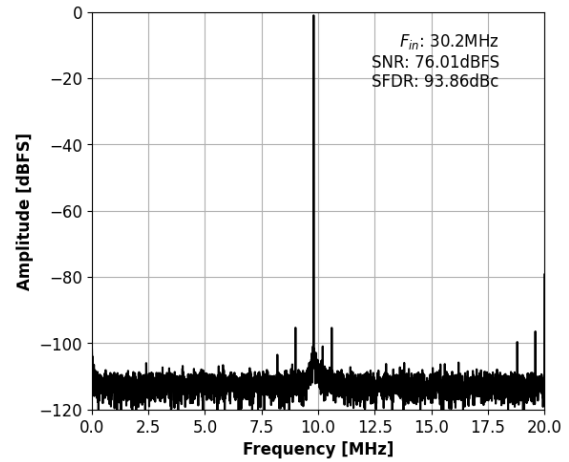

Figure 8: Single-Tone FFT with $f_{IN}=30.2\text{MHz}$.

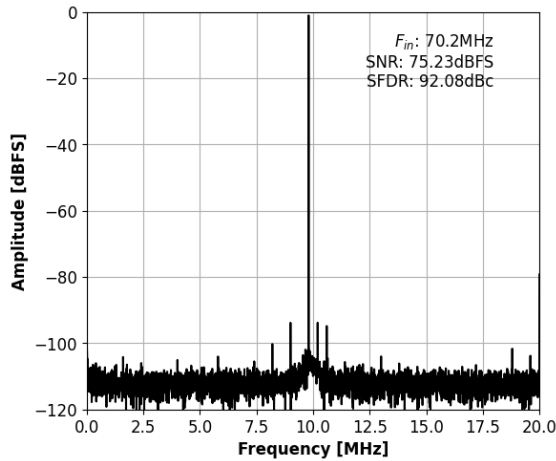

Figure 9: Single-Tone FFT with $f_{IN}=70.2\text{MHz}$.

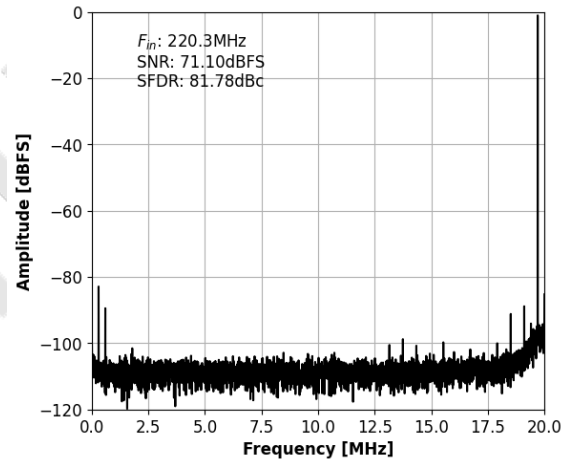

Figure 10: Single-Tone FFT with $f_{IN}=220\text{MHz}$.

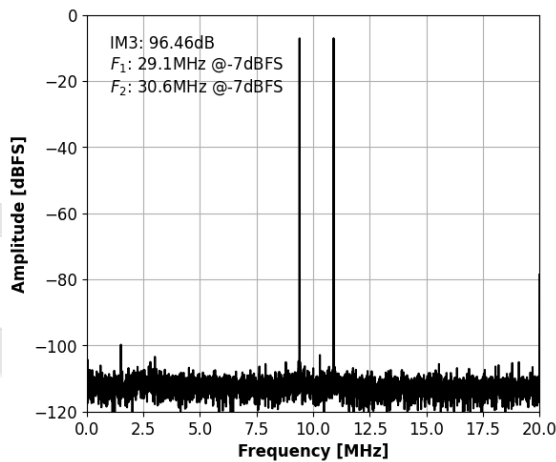

Figure 11: Two-Tone FFT with $f_{IN1}=29.1\text{MHz}$, $f_{IN2}=30.6\text{MHz}$.

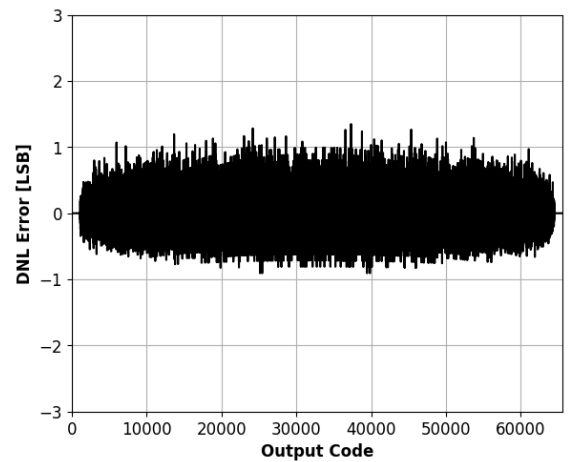

Figure 12: DNL Error with $f_{IN}=6.55\text{MHz}$.

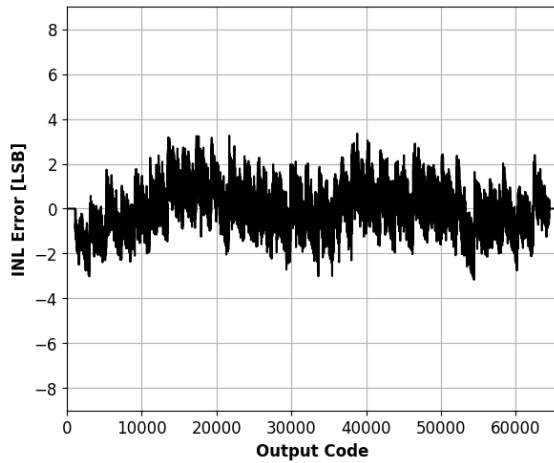

Figure 13: INL Error with $f_{IN}=6.55\text{MHz}$.

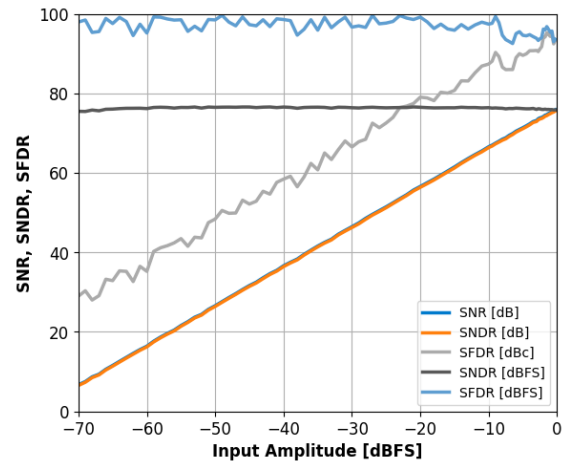

Figure 14: Single-Tone SNR, SNDR and SFDR vs. Input Amplitude with $f_{IN}=30.25\text{MHz}$.

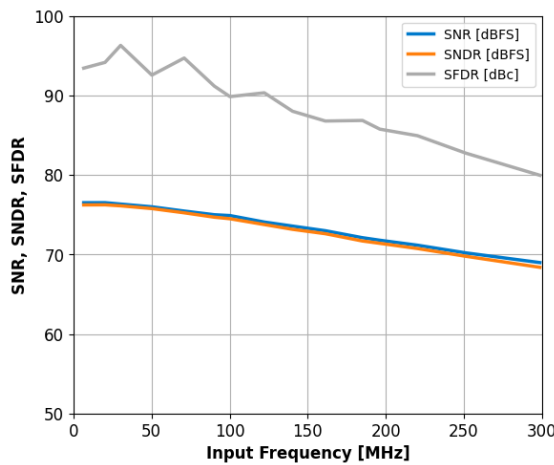

Figure 15: Single-Tone SNR, SNDR and SFDR vs. Input Frequency with $f_S=40\text{MHz}$.

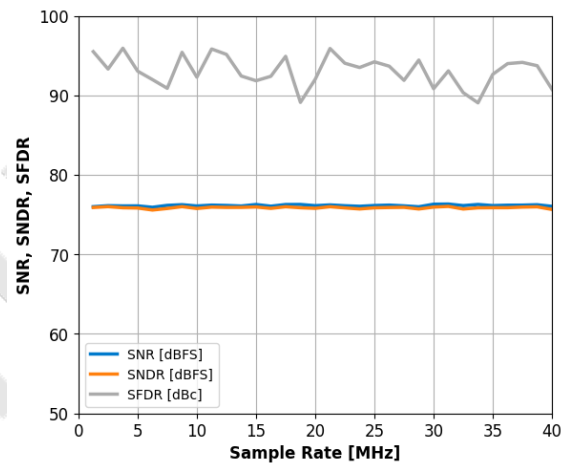

Figure 16: Single-Tone SNR, SNDR and SFDR vs. Sample Rate with $f_{IN}=30.25\text{MHz}$.

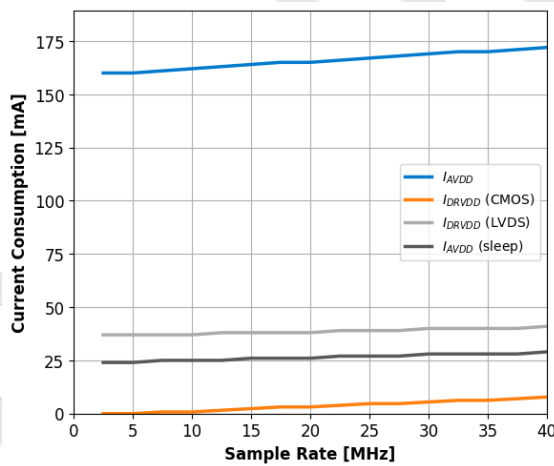

Figure 17: Current vs. Sample Rate.

EQUIVALENT CIRCUITS



Figure 18: Equivalent Clock Input Circuit.

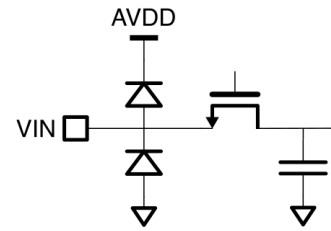

Figure 19: Equivalent Analog Input Circuit.

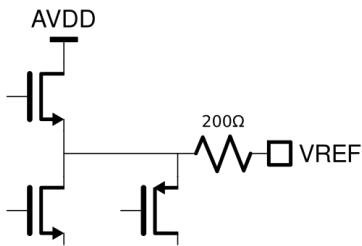

Figure 20: Equivalent VREF Circuit.

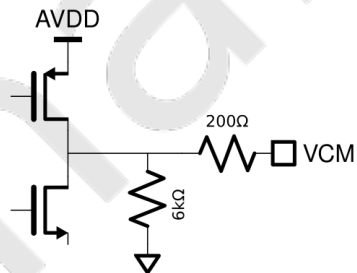

Figure 21: Equivalent VCM Circuit.

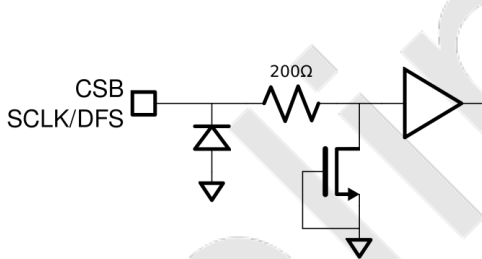

Figure 22: Equivalent CSB or SCLK/DFS Input Circuit.

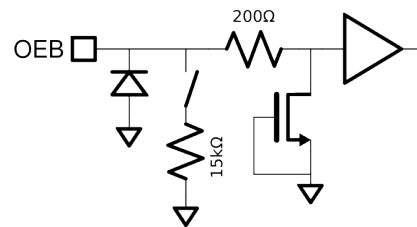

Figure 23: Equivalent OEB Input Circuit.

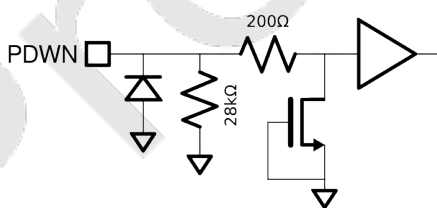

Figure 24: Equivalent PDWN Input Circuit.

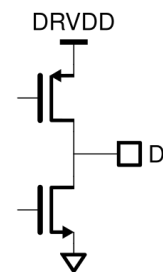

Figure 25: Equivalent Digital Output Circuit.



Figure 26: Equivalent LVDS output Circuit.



Figure 27: Equivalent SYNC Input Circuit.

Preliminary

THEORY OF OPERATION

ADC Architecture

The ADC uses a pipelined architecture and innovative patented switched-capacitor circuits. Its fully differential design provides exceptional immunity to power supply noise and minimizes reference voltage self-modulation. A built-in Sample-and-Hold (S/H) function is integrated into the input stage of the pipeline structure.

Analog Input

The input stage of the ADC behaves as a switched-capacitor network, presenting itself to the driving circuit as a combination of a switch and a sampling capacitor. The capacitor is reset prior to each conversion cycle, effectively eliminating non-linear memory effects commonly observed in some pipelined ADC architectures. The ADC does not include an internal common-mode bias therefore, the driving source must provide an appropriate common-mode voltage.

Differential Clock Input

The SD1150 features a differential clock receiver with an integrated common-mode bias. For proper operation, the clock inputs should be AC-coupled using 10nF capacitors.

Differential Clock Configuration. For optimal jitter performance, a differential clock source is recommended. The differential clock signals to CLK+ and CLK- should be connected through a 10nF AC-coupling capacitors.

Single-Ended Clock Configuration. If a single-ended clock source is used, the signal source should be AC-coupled to the CLK+ pin. In this configuration, a 10nF capacitor should be connected between the CLK- pin and analog ground to maintain proper biasing.

Clock Jitter Considerations. Clock jitter has a significant impact on the ADC's signal-to-noise ratio (SNR). The sensitivity to jitter increases with input signal frequency. For best performance, a low-noise differential clock with fast edge transitions should be used.

Note: The part can enter in manufacturing test mode if both differential clock inputs are held low for more than 1ms. This behavior can be prevented by writing 1 to register *0x4cf*, bit[15].

Clock Divider

The ADC includes a programmable clock divider that allows the input clock to be divided by integer values from 2 to 8. The divider is configured by setting register *0x463*, bits [7:5], to the desired division value. A value of 0 (default) bypasses the divider entirely.

By default, the divider starts asynchronously. If the application requires synchronization across multiple ADC devices, the SYNC pin provides means for aligning clock dividers to guarantee sampling on the same clock edge. If clock divider is bypassed, this feature is not needed.

Synchronization is enabled by setting register *0x463*, bit [10], to 1. When the bit is 0, SYNC pin is ignored. SYNC is a level sensitive, active high, reset pin that is captured on the falling edge of the input clock. As long as SYNC is high, the divider stays in reset. It starts dividing on the first falling clock edge after SYNC goes low.

Make sure that the falling edge of SYNC meets the specified setup and hold times relative to the input clock, as shown in Table 13. Pay attention to the length matching of the clock and SYNC routing to the multiple ADC chips. For test and debugging purposes, the level of received and captured SYNC signal can be read from register *0x4ff*, bit [10].

Clock Duty-Cycle Requirements. The ADC utilizes both the rising and falling edges of the input clock (or the divided clock, if the divider is enabled) for internal sampling operations. To achieve optimal performance, especially at the maximum sampling rate, the clock duty cycle should be as close to 50% as possible.

When the divider is enabled with an even divisor, a 50% duty cycle is guaranteed by design. If the application uses a clock with a non-ideal duty cycle, a Duty Cycle Stabilizer (DCS) can be enabled to improve performance.

ADC Self-Calibration

The ADC includes an automatic calibration mechanism that is executed at power-up to ensure optimal performance. It calibrates out capacitor mismatch and the effects of operational amplifier finite gain and bandwidth. For best results, calibration should be performed at the actual sampling rate used during operation. To support this, the device continuously monitors the sampling clock frequency and automatically re-triggers calibration if a significant change is detected. This feature can be disabled by setting register `0x4c9`, bit[0], to 1.

Manual calibration can also be initiated by toggling both `0xdc1`, bit[4] and `0xcc1`, bit[4] from 0 to 1. The calibration process is implemented using a state-machine architecture, ensuring a deterministic and predictable calibration time. By default the calibration takes 46 million ADC sampling clock cycles. Calibration completion status can be read from `0xdef`, bit[0], for the first ADC and `0xcef`, bit[0], for the second ADC after the status readback is enabled by writing `0x1c` to both `0xdeb` and `0xceb`. Bit value 1 indicates that calibration is complete.

In addition, the ADC supports a Background Calibration (BGC) mode, which is disabled by default. When enabled, parameters for compensating changes in operational amplifier gain and bandwidth are continuously updated. BGC is beneficial in environments with large temperature variations near the hot end of the specified operating temperature range. For its operation, BGC uses a dither signal which is injected into the ADC input signal path. This dither consumes approximately 0.8dB of the ADC's input range, resulting in earlier clipping compared to when BGC is disabled. When BGC is enabled calibration completion status bit remains 0.

To enable BGC:

- Write `0b01` to register `0xde1`, bits [15:14]
- Write `0b01` to register `0xce1`, bits [15:14]
- Write `0x0d80` to register `0xdcf`
- Write `0x0d80` to register `0xccf`
- Write `0b0` to register `0xde3`, bit [3]
- Write `0b0` to register `0xce3`, bit [3]

Calibration parameters can be altered to optimize ADC performance and the duration of the calibration according to Table 19. High Performance settings improve the low frequency SFDR compared to the default settings while the High Speed Settings minimize the calibration time at the cost of small SFDR and SNDR degradation. If the parameters are altered, the calibration has to be reinitiated as described earlier.

Table 19. Calibration Settings.

Register Address	Default Value	High Performance Value	High Speed Value
<code>0xccd</code>	<code>0x1483</code>	<code>0x3483</code>	<code>0x348c</code>
<code>0xcd5</code>	<code>0x1483</code>	<code>0x3483</code>	<code>0x348c</code>
<code>0xcd</code>	<code>0x16c3</code>	<code>0x36c3</code>	<code>0x36cc</code>
<code>0xce1</code>	<code>0xbbe8</code>	<code>0xbb80</code>	<code>0xbb20</code>
<code>0xcd</code>	<code>0x1483</code>	<code>0x3483</code>	<code>0x348c</code>
<code>0xdd5</code>	<code>0x1483</code>	<code>0x3483</code>	<code>0x348c</code>
<code>0xdd</code>	<code>0x16c3</code>	<code>0x36c3</code>	<code>0x36cc</code>
<code>0xde1</code>	<code>0xbbe8</code>	<code>0xbb80</code>	<code>0xbb20</code>
Duration (clock cycles)	46M	25M	6.3M

Stand-by and Power-Down Modes

The SD1150 supports two power-saving modes, power down and stand-by, that can be used when the ADCs are not actively sampling. In both modes, the SPI interface (if enabled) remains operational.

Power-Down Mode. This mode disables most of the internal circuitry, resulting in the lowest residual supply current. It is ideal for applications requiring minimal power consumption during idle periods. Power-down mode can be enabled via:

- The PDWN pin when operating in the external pin mode, or
- Setting register *0x457*, bit[7], to 1.

Stand-by Mode. Stand-by mode offers a faster wake-up time compared to power-down mode, at the cost of slightly higher residual current. It is suitable for applications that require rapid recovery from idle states. To enable stand-by mode, set register *0x457*, bits [3] and [8], to 1.

Note: It is recommended to disable the ADC auto-calibration when using stand-by mode to avoid unintended calibration cycles during transitions.

Commonly Used Functions

The SD1150 offers several functions available via dual function pin controls (external pin mode vs. SPI mode). The SD1150 detects the SPI mode during the first SPI transaction after power-up. If the user does not want to program the device via the SPI interface, the dual function is available.

Duty-Cycle Stabilizer. The Duty-Cycle Stabilizer (DCS) retimes the falling edge of the clock thus providing an internal clock signal with a 50% duty cycle. The DCS is useful in systems where the input clock has an uneven duty cycle. It can be enabled in the following ways:

- Via the DCS pin when operating in the external pin mode.
- Via register control by setting register *0x457*, bit[1], to 1.

Data Format Select. Data Format Select (DFS) can be used to select between offset binary or two's complement when operating in the external pin mode.

Output Enable (active-low, **OEB**). If the OEB pin is low, the output data drivers and output clock are enabled. If the OEB pin is high, the CMOS output data drivers and clock are placed in a high-impedance state; while the LVDS drivers are switched off. The OEB function is not intended for rapid access to a shared data bus.

Common-Mode Voltage. The VCM pin outputs the analog input common-mode bias voltage (VCM). This pin provides a stable DC reference that can be used to set the ADC input common-mode level, either directly through a passive network or indirectly as the common-mode reference for a driving amplifier. In typical applications, the default common-mode voltage is suitable and requires no adjustment. The common-mode voltage level is programmable through register *0xf11*, bits [4:3].

VREF The ADC supports both internal (default) and external voltage reference sources, selectable via the VREF pin.

The selection between internal and external reference voltage is via made register control: setting register *0x45d*, bit[5], to 1 selects the external reference.

Internal Reference Output. When the internal voltage reference is used, the VREF pin can function as a reference output. This output can be enabled by setting register *0x45d*, bits [14:13], to 0x3.

The internal vref can be adjusted with *0x45d* bits [4:1]. Usually, the default value yields the optimal performance.

DSP

The DSP path, shown in Figure 28, includes functionality for processing the output data of two ADCs operated as an IQ pair or independently. All functions can be bypassed or disabled if not needed. The main blocks in the signal chain are input multiplexer, sample delay control, gain and offset correction, phase correction, digital down converter (DDC), and decimator. Refer to APP-NOTE 100 (*Understanding the DSP Features in Plural™ Family of ADCs*) for more details on this topic.

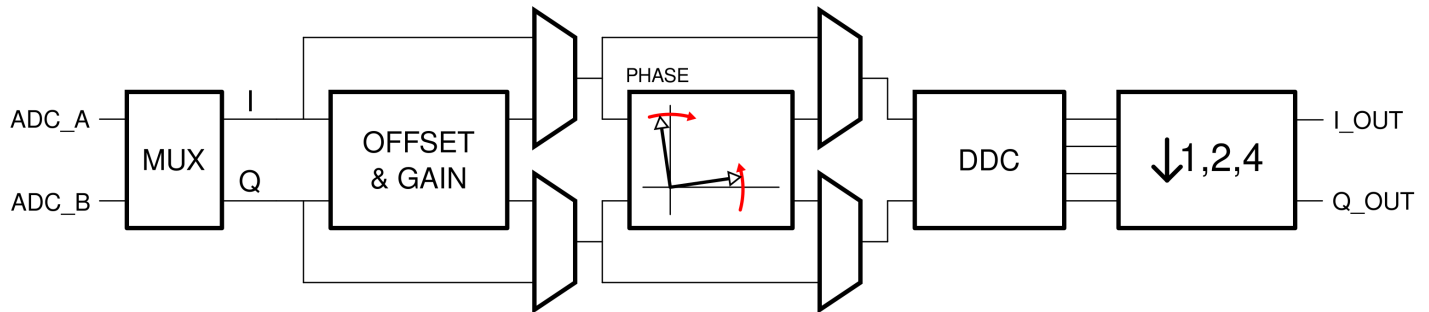

Figure 28: SD1150 DSP Top-Level Diagram.

Input MUX

The DSP block has two inputs, both with a multiplexer for selecting the source signal. By default ADC B feeds the I (in-phase) input and ADC A the Q (quadrature) input. The MUX allows crossing the inputs, feeding the same ADC to both inputs, and using the average of the two ADC outputs as a source. The multiplexer is controlled by register *0xf09*.

Delay, Offset, and Gain

Datapath configuration and sample delay control bits are in register *0x807*. Gain and offset are controlled by registers *0x809*, *0x80b*, *0x80d*, and *0x80f*.

IQ Phase Correction

The block diagram of IQ phase correction block is shown in Figure 29. It can be used to add or subtract a small amount of I signal from the Q and vice versa to compensate for the phase error of the input signal. The correction range is about ± 14 degrees and it is controlled by the *0x811* register. This simple scheme affects both the signal phase and gain and thus has to be used together with the gain correction block to minimize both the gain and phase mismatch.

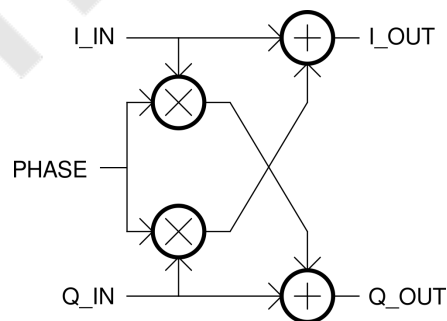

Figure 29: SD1150 IQ phase correction.

Digital Down Converter (DDC)

Figure 30 shows the block diagram the DDC. It consists of two numerically controlled oscillators (NCOs), digital multipliers, adders, and multiplexers. It can be programmed for two modes of operation. Mode 1 provides two independent paths with a real input and a complex (IQ) output. Mode 2 is used when the two ADCs operate as an IQ pair. It accepts IQ input and

supplies IQ output using NCO1 as local oscillator (LO).

The DDC is enabled in the datapath using a bit in register *0x807*. Its control bits are collected in register *0x813*, which has bits for enabling the I and Q paths and selecting the NCOs. The mode is selected using bits [14:13], value 0b01 selecting mode 1 and value 0b10 mode 2. In mode 2 the spectral inversion can be done by manipulating the signs of the adder inputs using bits [11:8], value 0b1101 is the default and value 0b0001 inverts the frequency axis.

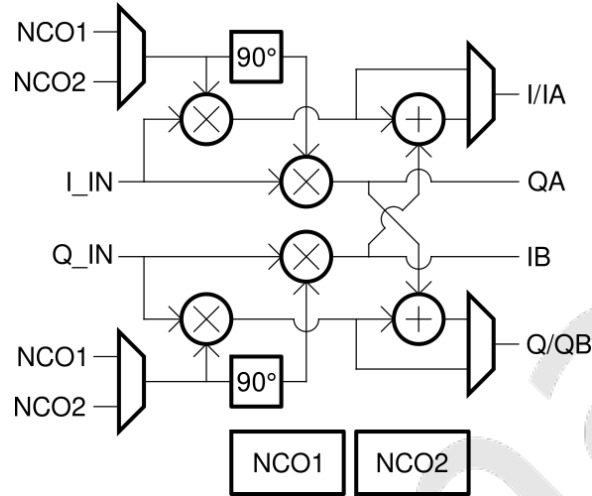

Figure 30: SD1150 DDC.

NCO

The two NCO instances are implemented using a direct digital synthesizer (DDS). It can produce a LO frequency ranging from 0 to F_s using a 48-bit frequency control word, which is calculated as $f/F_s * 2^{48}$. To program the frequency, the DDC must be first enabled and a stable input clock must be present. Registers *0x815*, *0x817*, and *0x819* control NCO1 and registers *0x81b*, *0x81d*, and *0x81f* control NCO2. After the new frequency is written to the registers it has to be loaded by setting load bit high and then clearing it. NCO1 uses bit [0] and NCO2 bit [1] in register *0x82b* for this purpose.

Decimator

The final block in the DSP signal chain is the decimator, which supports rates 2 and 4 or can be bypassed. It is based on two cascaded half-band FIR filters with the frequency response shown in Figure 31. The operation of the decimator is controlled by three registers *0x82f*, *0x82d*, and *0x805* that configure the decimator, set the rate, and DSP output clock divider.

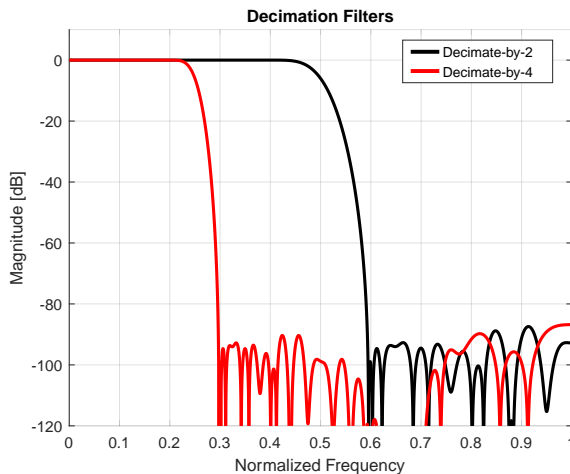

Figure 31: SD1150 Decimator Frequency Response.

Table 20 provides the register values for each mode of operation.

Table 20. Decimation Modes.

Mode	DSP Output Clock Rate	Reg 0x82f	Reg 0x82d	Reg 0x805
Bypass	1	0x0001	0x0000	0x0000
Decimate by 2	1/2	0x0006	0x0010	0x0001
Decimate by 4	1/4	0x0026	0x0020	0x0002
DDC mode 1 & Decimate by 2	1	0x000E	0x0010	0x0000
DDC mode 1 & Decimate by 4	1/2	0x002E	0x0020	0x0001
Interleave & Decimate by 2	1/2	0x0016	0x0000	0x0000
Interleave & Decimate by 4	1/4	0x0032	0x0010	0x0001

Interleave and Decimate Mode

To operate the two ADC cores as an interleaved unit the input clock must be provided at twice the core sampling rate. The decimator is programmed per Table 20 and the ADCs are configured for interleaving using the following steps, which can only be performed after a stable input clock is present. Interleaving without decimation is not supported.

1. Write 0x0022 to register 0xf0f to enable clock division by two.
2. Write 0x0000 to register 0xcc3 and 0x0002 to register [ADC_A_ADC_CORE_CLK_CTRL_register] to set the clocks of the two ADC cores 180 degrees apart.
3. Toggle clock divider reset bit by first writing 0x0003 and then 0x0043 to register 0xf07.
4. Program digital logic to work with 180 degree sampling clock offset by writing 0x000C to register 0xde7.

In this mode the digital output data is present on both ADC A and ADC B output pins. The redundant output pins can be turned off to save power and reduce IO noise.

Down Mixing Before Decimation

When decimating by two, the signals located in the upper half of the first Nyquist zone fall into the stop band of the decimation filter. Similarly the decimate by four mode passes signals up to $0.1F_s$ while blocking them from there on up to $0.9F_s$. The DDC block has a low power mode that uses a simple sequence of +1 and -1 multiplications that can mix the signal down with LO at $F_s/2$ or $F_s/4$ before decimation. This is enabled by the following steps, which can be executed only after a stable input clock is present.

1. Enable DDC in the datapath by clearing register 0x807 bit[9].
2. Write 0x59AB for LO of $F_s/2$ and 0x392B for LO at $F_s/4$ to register 0x813.
3. Load the LO frequency by first writing 0x0001 and then 0x0000 to register 0x82b.
4. Enable DDC low power mode by writing 0x59EB for LO of $F_s/2$ and 0x396B for LO of $F_s/4$ to register 0x813.

An alternative and more versatile way to mix the signal down before decimation is to use the DDC. One significant difference is the digital output in IQ format.

In interleave and decimate mode, programming the part for mixing down with $F_s/4$ is the same as mixing down with $F_s/2$ above, as the definition of F_s has changed by a factor of two. Setting the LO at $F_s/2$, which means multiplying every other sample by +1 and every other by -1, can be accomplished in two ways: in the board level by crossing the + and - of the analog input of one of the converters or using the following steps.

1. Enable DDC in the datapath by clearing register 0x807 bit [9].
2. Write 0x58AB to register 0x813.
3. Set register 0x807 bit [0].
4. Load the LO frequency by first writing 0x0001 and then 0x0000 to register 0x82b.
5. Clear register 0x807 bit [0].

6. Enable DDC low power mode by writing 0x58EB to register 0x813.

Digital IOs

When the DSP is enabled the I-output is mapped to the ADC B output pins and the Q-output is mapped to the ADC A output pins. The rate of the digital output clock relative to the sampling clock (input clock after the clock divider) is specified in Table 20.

When the DDC is programmed to mode 1, it produces two IQ output signals each of which is interleaved into the corresponding ADC's output pins sending out the I and Q samples on alternate clock cycles. This output mode is enabled by writing 0b01 to register 0x4b5, bits [10:9]. The ADC B overrange pin (not available in channel multiplexed mode, for the LVDS interface) can be programmed to serve as IQ indicator that toggles on every output clock cycle, by setting register 0x4cd, bit [7]. A high value indicates a Q sample in A output and I sample in B output.

This mode suffers from a startup condition that instead of pairing sample Q(n) with sample I(n), sometimes Q(n) sample is paired with sample I(n-1) or I(n+1). Which of the two states is active can be detected with the following procedure and then handled properly in the receiver.

1. Program DSP to the desired mode of operation.
 - a. If decimating by 2, program the DDS to frequency 0x200000000000
 - b. if decimating by 4, program the DDS to frequency 0x100000000000
2. Load the frequency as described earlier (this creates a deterministic digital test pattern).
3. Set DDC output mux (register 0x813, bits [14:13]) to 0b11 to enable the test pattern.
4. Observe the MSB of the received digital signal de-interleaved into I and Q. Correct pairing shows the MSB of the Q-channel leading the I-channel by one sample. The correct state can be identified by delaying the MSB of Q and comparing it to the MSB of I. If any bit in the four-sample-long test pattern shows a mismatch, the samples are paired incorrectly. They should be realigned by applying a one-sample delay to Q of the B output and I of the A output in the receiver. The detection can be made with a simple XOR based circuit (see Listing 1).
5. Restore DDC output mux value to 0b01 and program the DDS(s) to the desired LO frequency.

Listing 1: The IQ-alignment SystemVerilog Module.

```

module iq_align (
    input logic clk,           // clock
    input logic [15:0] da, db, // 16-bit input data streams
    input logic orb,          // Channel B overrange bit. Its second function identifies
                              // whether the current data belongs to Q or I
    input logic sel,          // Select between da and db, for alignment check
    input logic align_now,    // Pulse to perform alignment. Must be minimum 4 clocks long
    input logic capture_iq_flag, // Pulse to capture orb
    input logic reset_delay,  // Reset delay to 0
    output logic [15:0] da_i, da_q, // I/Q components of channel A
    output logic [15:0] db_i, db_q // I/Q components of channel B
);
// Synchronize locally generated I/Q indicator (iq_flag) to the one provided by
// the chip on 'orb' pin.
logic iq_flag;
always_ff @(posedge clk)
    iq_flag <= ~(capture_iq_flag ? orb : iq_flag);

// Split the input data into I and Q streams
logic [15:0] da_i0, db_i0, da_q0, db_q0, da_i1, db_q1;
always_ff @(posedge clk) begin
    if (iq_flag) begin
        da_i0 <= da; // High flag indicates I on channel A
        db_q0 <= db; // High flag indicates Q on channel B
    end else begin
        da_q0 <= da;
        db_i0 <= db;
        da_i1 <= da_i0;
        db_q1 <= db_q0;
    end
end

// Output data is launched on every other clock cycle, applying a delay to da_i and db_q
// when misalignment is detected
logic da_q_d_15, db_q_d_15, delay;
always_ff @(posedge clk)
    if (~iq_flag) begin
        da_q <= da_q0;
        da_i <= delay ? da_i1 : da_i0;
        da_q_d_15 <= da_q[15];
        db_i <= db_i0;
        db_q <= delay ? db_q1 : db_q0;
        db_q_d_15 <= db_q[15];
    end

// Compare the MSB of I and delayed Q to detect misalignment.
// When the alignment is correct, the the signals are identical.
wire misaligned = sel ? da_i[15]^da_q_d_15 : db_i[15]^db_q_d_15;

// Enable delay, if misalignment is detected.
always_ff @(posedge clk)
    if (reset_delay)
        delay <= 1'b0;
    else if (align_now & misaligned)
        delay <= 1'b1;
endmodule

```



Listing 1 shows an example SystemVerilog implementation of the alignment detection and correction logic. This implementation is provided as a reference and may require adjustments to meet specific customer requirements.

SERIAL PORT INTERFACE

The SD1150 uses a 3-wire Serial Port Interface (SPI) that gives the user flexibility to configure the converter for specific functions, depending on the application, through a register space provided inside the ADC. The interface signals are:

- SCLK: defines the bit rate at which serial data is driven onto, and sampled from, the bus;
- CSB: defines the boundaries of a basic data 'unit', comprised of multiple serial bits;
- SDIO: is the serial data IO wire;

The read and write cycles are described in the figure below. The address space is 13 bits long ($A<12:0>$) and the data is 16 bits wide ($D<15:0>$). The complete instruction cycle is 32-bits long. The falling edge of CSB combines with the rising edge of SCLK marks the start of the instruction cycle. On a write transaction, the target register is updated on the falling edge of SCLK.

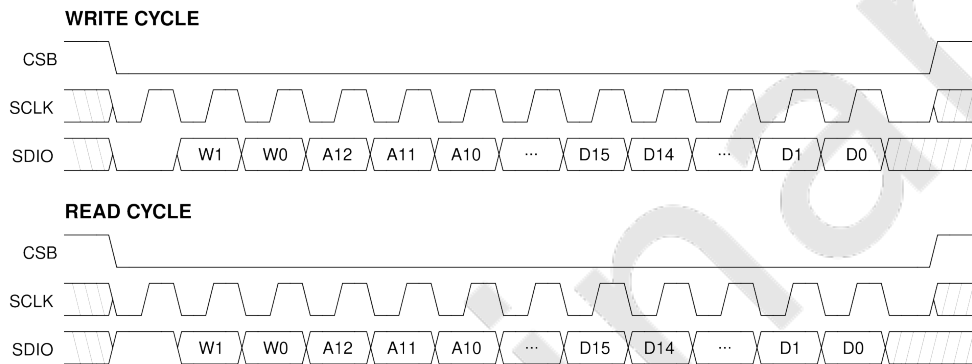

Figure 32: 3-wire SPI timing.

Table 21. SPI Timing.

PARAMETER	TEMP	MIN	TYP	MAX	UNIT
Setup time between the data and the rising edge of SCLK	t_{DS}	2			ns
Hold time between the data and the rising edge of SCLK	t_{HD}	2			ns
Period of the SCLK	t_{SCLK}	40			ns
Setup time between CSB and SCLK	$t_{S,CSB-SCLK}$	2			ns
Hold time between CSB and SCLK	$t_{H,CSB-SCLK}$	2			ns
Minimum period that SCLK should be in a logic high state	$t_{SCLK,high}$	10			ns
Minimum period that SCLK should be in a logic low state	$t_{SCLK,low}$	10			ns
Time from SCLK falling edge to SDIO switching from input to output	$t_{SDIO,EN}$	10			ns
Time from SCLK falling edge to SDIO switching from output to input	$t_{SDIO,DIS}$	10			ns

Two bits, W1 and W0, determine how many bytes of data that can be transferred in the same write cycle (see Table 22). If more than 16 bits (2 Bytes) of data are being transferred the address is increased sequentially.

Table 22. SPI Word Length.

[W1,W0]	Data length
00	Not supported
01	Two bytes of data can be transferred
10	Not supported
11	Four bytes of data can be transferred

The SPI pins should not be active when the full dynamic performance of the ADC is required. Noise from SCLK, CSB and the data transactions can degrade ADC performance.

Preliminary

OUTPUT MODE

Data Scrambler

Interference originating from the digital outputs of the ADC can be difficult to eliminate entirely. Such interference may result from capacitive or inductive coupling mechanisms, or from shared impedance paths in the ground plane. Even minimal coupling coefficients can introduce deterministic spurious tones into the ADC's output frequency spectrum. To mitigate this, digital output scrambling techniques can be employed prior to off-chip transmission. By randomizing the bit patterns, the spectral energy of these spurs is dispersed, effectively reducing their peak amplitudes and minimizing their impact on signal integrity.

The SD1150 can apply an exclusive-OR logic operation between the LSB and all other data output bits, while the LSB, overflow and clock outputs are not affected.



When this function is used, the receiver must apply the same function to unscramble the received data.

The data scrambler is enabled by setting control register *0x4b5*, bit[13], to 1.

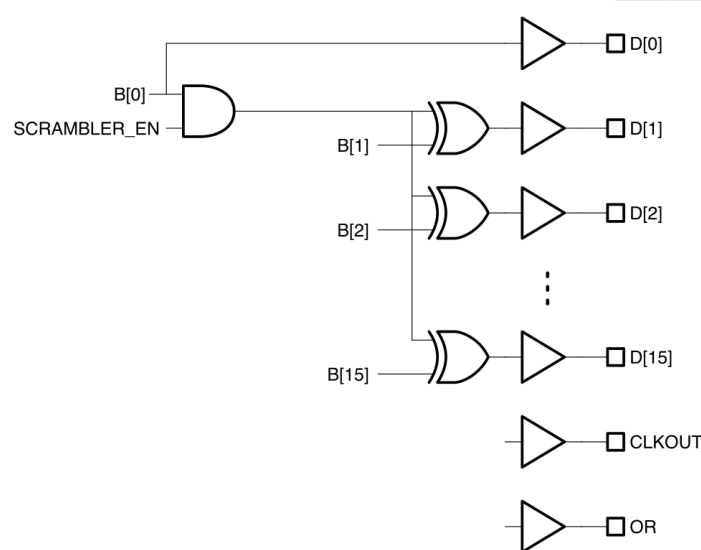

Figure 33: SD1150 Data Scrambler.

Alternate Bit Polarity

The alternate bit polarity is particularly effective to suppress digital feedback and minimize noise coupling on the PCB when the ADC input signal is near mid-scale and of very small amplitude. In this case, the digital output tends to toggle between patterns dominated by either logic high or logic low states. This synchronized switching of multiple bits can induce significant transient currents in the ground plane, leading to increased digital noise. This mode, when activated, inverts all odd-numbered data output bits prior to the output buffer stage while even-numbered bits, along with the overflow and clock output, remain unaffected thus ensuring that approximately half of the output bits transition are high while the other half transition are low. This balanced switching behavior helps cancel out opposing current flows in the ground return path, thereby reducing overall ground noise. At the receiving end, the original data can be reconstructed by inverting the same odd-numbered bits. This mode operates independently of the digital output randomization feature, both functions can be enabled or disabled separately. The Alternate Bit Polarity mode is configured via serial programming of control register *0x4b5*, bit[14].

Output Test Modes

The output test options are described in Table 23 and are selected via SPI programming at register *0x4b5*, bits [5:2].

When an output test mode is enabled, the analog section of the ADC is disconnected from the digital back-end blocks and the test pattern is run through the output formatting block. These tests require an active input clock.

There are two pseudo-random number generators available, PN23 and PN9. The PN23 generator ($X^{23}+X^{18}+1$), selected by register $0x4b5$, bits [5:2], set to $0x5$, can be reset by setting register $0x4b5$, bit [12], low; while the PN9 generator (X^9+X^6+1), selected by register $0x4b5$ set to $0x6$, can be reset by setting register $0x4b5$, bit [11], low.

Table 23. Output Test Modes.

Mode	Function
0	Pass-Through
1	Midscale
2	+FS
3	-FS
4	Checkerboard
5	PN23
6	PN9
7	1/0 word toggle
8	User input
9	1/0 bit toggle
10	Unused
11	1-bit high
12	Mixed frequency
13	Unused
14	Unused
15	Ramp

Pass-through and test patterns 1, 2, 3, 5 and 6 are subject to output formatting, while the other test modes are not. Test patterns 1, 8 and 15 can be applied to either one channel or both channels using $0x4b5$, bit[7:6]. Patterns 4 and 7 can be toggled between the pattern and its inverse while test pattern 8 can be selected using registers $0x4bb$, $0x4bd$, $0x4bf$ and $0x4c1$.

CONTROL REGISTERS

This section describes the most commonly used control registers. For a description of the complete register map, refer to Appendix A: Register Map.

Each register is presented in the following format:

Address: <HEX value>		RW or RO	Default: <HEX value>
bit field	default value	field description.	

Notes

- **RW** = Read/Write
- **RO** = Read-Only
- For read-only registers, the default value is omitted.
- Registers not listed in these tables should not be written.



When updating control register values, always use a read-modify-write procedure. Some registers include reserved bit fields for internal engineering purposes. This approach ensures that these reserved bits remain unchanged and prevents unintended modifications.

CHIP TOP:

Address: 0x457		RW	Default: 0x0015
[0]	0x1		Duty Cycle Stabilizer enable (see [paragraph_DCS]). 0: Disable 1: Enable
[1]	0x0		Duty Cycle Stabilizer on/off in SPI mode (see [paragraph_DCS]). 0: Off 1: On
[2]	0x1		External output enable (OE/OEB) control (see [paragraph_OEB]). 0: Output Enabled 1: Output depends on pin OE/OEB
[3]	0x0		Output disable (see [paragraph_OEB]). 0: Output depends on OE/OEB control and OE/OEB pin 1: Disabled
[6:4]	0x1		Reserved.
[7]	0x0		Software power down. 0: Active State 1: Power Down
[8]	0x0		Software stand-by mode. 0: Active State 1: Stand-by Mode

Address: 0x463		RW	Default: 0x0019
[0]	0x1		Enable clock receiver. 0: Disable 1: Enable
[4:1]	0xc		Reserved.
[7:5]	0x0		Clock RX divider control. 0: Bypass 1: Divide by 2 2: Divide by 3 3: Divide by 4 4: Divide by 5 5: Divide by 6 6: Divide by 7 7: Divide by 8
[8]	0x0		Enable on-chip 100Ohm termination. 0: Disable 1: Enable
[9]	0x0		Clock polarity control when DCS is enabled. 0: Disable 1: Invert
[10]	0x0		Enable SYNC pin synchronization. 0: Disable 1: Enable

Address: 0x465		RW	Default: 0x0004
[2:0]	0x4		Output data interleaver. 0: pass through, no interleaving 1: pass through, channels swapped, no interleaving 2: N/A 3: N/A 4: parallel ADC_A/ADC_B interleaving 5: parallel ADC_B/ADC_A interleaving 6: even-odd interleaving 7: odd-even interleaving

Address: 0x473		RW	Default: 0x0000
[4:0]	0x0		Reserved.
[9:5]	0x0		Output data delay in parallel CMOS mode. The output data delay is increased by 250ps * (register value) with respect to the clock
[13:10]	0x0		Reserved.
[14]	0x0		Output data sending clock polarity in parallel CMOS mode. 0: Not inverted 1: Inverted
[13:10]	0x0		Output clock delay. The output clock delay is increased by 250ps * (register value) with respect to the data
[14]	0x0		Output clock polarity. 0: Not inverted 1: Inverted

Address: 0x4b5		RW	Default: 0x18c0
[1:0]	0x0		Output format. 0: Offset binary 1: Two's complement 2: Gray code 3: Offset binary
[5:2]	0x0		Output test mode select (see Table 23).
[6]	0x1		Output test channel CH. A 0: Disable 1: Enable
[7]	0x1		Output test channel CH. B 0: Disable 1: Enable
[8]	0x0		Output test toggle mode. Toggle between user test pattern 0 and 1.
[10:9]	0x0		Reserved.
[11]	0x1		PN9 generator reset (active low).
[12]	0x1		PN23 generator reset (active low).
[13]	0x0		Enable the output data scrambler. 0: Disable 1: Enable
[14]	0x0		Enable alternate bit polarity switch. 0: Disable 1: Enable

ADC A:

Address: 0xdc1		RW	Default: 0xbfff
[3:0]	0xf		Reserved.
[4]	0x1		Calibration soft reset (active low).
[15:5]	0x5f9		Reserved.

See Table 19 for valid configurations for the following registers:

Address: 0xdcd		RW	Default: 0x1483
[2:0]	0x3		Stg1 calibration convergence speed in foreground mode (see Table 19).
[11:3]	0x90		Reserved.
[13:12]	0x1		Stg1 calibration randomization sequence in foreground mode (see Table 19).

Address: 0xdd5		RW	Default: 0x1483
[2:0]	0x3		Stg2 calibration convergence speed in foreground mode (see Table 19).
[11:3]	0x90		Reserved.
[13:12]	0x1		Stg2 calibration randomization sequence in foreground mode (see Table 19).

Address: 0xddd		RW	Default: 0x16c3
[2:0]	0x3		Stg3 calibration convergence speed in foreground mode (see Table 19).
[11:3]	0xd8		Reserved.
[13:12]	0x1		Stg3 calibration randomization sequence in foreground mode (see Table 19).

Address: 0xde1		RW	Default: 0xbbe8
[7:0]	0xe8		Time allocated for calibration (see Table 19).
[8]	0x1		Enable calibration (see Table 19).
[9]	0x1		Enable foreground calibration (see Table 19).
[10]	0x0		Reserved.
[11]	0x1		Enable stg1 calibration (see Table 19).
[12]	0x1		Enable stg2 calibration (see Table 19).
[13]	0x1		Enable stg3 calibration (see Table 19).
[14]	0x0		Background calibration parallel mode (see Table 19).
[15]	0x1		Disable background calibration mode for all stages (see Table 19).

ADC B:

Address: 0xcc1		RW	Default: 0xbfff
[3:0]	0xf		Reserved.
[4]	0x1		Calibration soft reset (active low).
[15:5]	0x5f9		Reserved.

See Table 19 for valid configurations for the following registers:

Address: 0xccd		RW	Default: 0x1483
[2:0]	0x3		Stg1 calibration convergence speed in foreground mode (see Table 19).
[11:3]	0x90		Reserved.
[13:12]	0x1		Stg1 calibration randomization sequence in foreground mode (see Table 19).

Address: 0xcd5		RW	Default: 0x1483
[2:0]	0x3		Stg2 calibration convergence speed in foreground mode (see Table 19).
[11:3]	0x90		Reserved.
[13:12]	0x1		Stg2 calibration randomization sequence in foreground mode (see Table 19).

Address: 0xcd8		RW	Default: 0x16c3
[2:0]	0x3		Stg3 calibration convergence speed in foreground mode (see Table 19).
[11:3]	0xd8		Reserved.
[13:12]	0x1		Stg3 calibration randomization sequence in foreground mode (see Table 19).

Address: 0xce1		RW	Default: 0xbbe8
[7:0]	0xe8		Time allocated for calibration (see Table 19).
[8]	0x1		Enable calibration (see Table 19).
[9]	0x1		Enable foreground calibration (see Table 19).
[10]	0x0		Reserved.
[11]	0x1		Enable stg1 calibration (see Table 19).
[12]	0x1		Enable stg2 calibration (see Table 19).
[13]	0x1		Enable stg3 calibration (see Table 19).
[14]	0x0		Background calibration parallel mode (see Table 19).
[15]	0x1		Disable background calibration mode for all stages (see Table 19).

ADC BRING-UP

The SD1150 does not require a specific power-up sequence; however, it is recommended to apply the DRVDD first followed by the AVDD.

Preliminary

ORDERING INFORMATION

This product is protected by several U.S. Patents (www.silannasemi.com/patents).

Preliminary

PACKAGE DRAWING

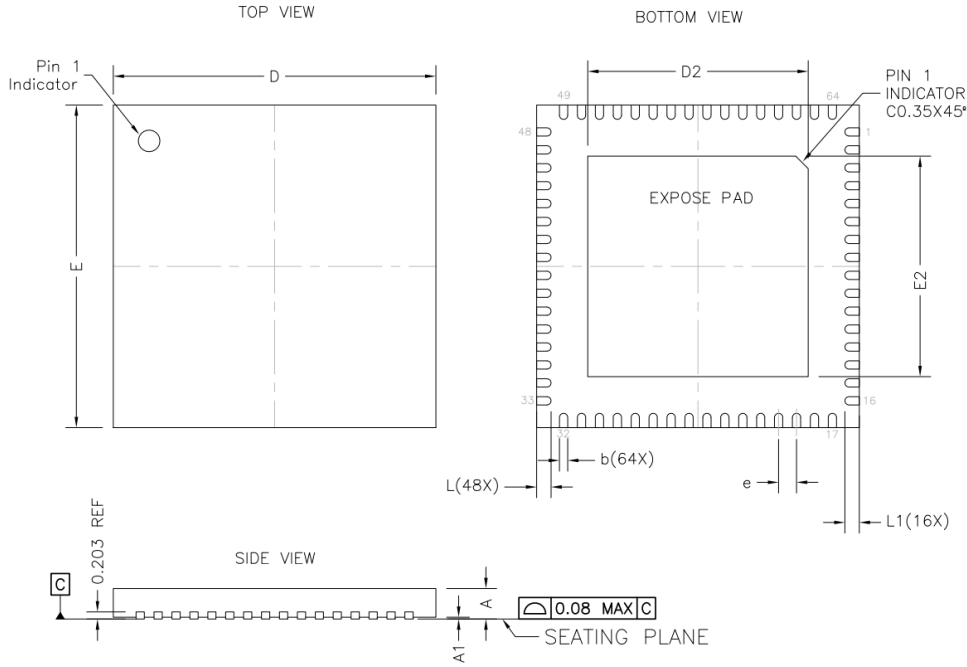

DIMENSION TABLE			
SYMBOL	MINIMUM	NOMINAL	MAXIMUM
A	0.70	0.75	0.80
A1	0.00	0.02	0.05
b	0.20	0.25	0.30
D	8.90	9.00	9.10
D2	6.10	6.15	6.20
E	8.90	9.00	9.10
E2	6.10	6.15	6.20
e	0.50 BSC		
L	0.35	0.40	0.45
L1	0.33	0.38	0.43

- NOTE:
1. Dimensioning and tolerancing conform to ASME Y14.5-2009
 2. All dimensions are in millimeters
 3. N is the total number of terminals
 4. Unilateral coplanarity zone applies to the exposed pas as well as the terminals
 5. Lead Finish: 100% Sn

Figure 34: Package Dimensions.

APPENDIX A: Register Map

This section provides a comprehensive description of the complete register map, detailing all available control and status registers within the device.

0x400 - CHIP_TOP

Address: 0x455		RW	Default: 0x0001
[0]	0x1		Soft reset (active low).

Address: 0x457		RW	Default: 0x0015
[0]	0x1		Duty Cycle Stabilizer enable (see [paragraph_DCS]). 0: Disable 1: Enable
[1]	0x0		Duty Cycle Stabilizer on/off in SPI mode (see [paragraph_DCS]). 0: Off 1: On
[2]	0x1		External output enable (OE/OEB) control (see [paragraph_OEB]). 0: Output Enabled 1: Output depends on pin OE/OEB
[3]	0x0		Output disable (see [paragraph_OEB]). 0: Output depends on OE/OEB control and OE/OEB pin 1: Disabled
[6:4]	0x1		Reserved.
[7]	0x0		Software power down. 0: Active State 1: Power Down
[8]	0x0		Software stand-by mode. 0: Active State 1: Stand-by Mode

Address: 0x45d		RW	Default: 0x0095
[0]	0x1		ADC reference voltage enable. 0: Disabled 1: Enabled
[4:1]	0xa		ADC reference voltage value. 0: Lowest ... 15: Highest
[5]	0x0		Set reference. 0: Internal 1: External from VREF pin
[11:6]	0x2		Reserved.
[12]	0x0		Enable selection between Internal and External VREF selection via bit 5. 0: Bit [5] selection disabled 1: Bit [5] selection enabled
[13]	0x0		Enable selection of VREF out via bit 14. 0: Bit [14] selection disabled 1: Bit [14] selection enabled
[14]	0x0		Enable VREF pin as reference voltage output. 0: Disabled 1: Enabled

Address: 0x463		RW	Default: 0x0019
[0]	0x1		Enable clock receiver. 0: Disable 1: Enable
[4:1]	0xc		Reserved.
[7:5]	0x0		Clock RX divider control. 0: Bypass 1: Divide by 2 2: Divide by 3 3: Divide by 4 4: Divide by 5 5: Divide by 6 6: Divide by 7 7: Divide by 8
[8]	0x0		Enable on-chip 100Ohm termination. 0: Disable 1: Enable
[9]	0x0		Clock polarity control when DCS is enabled. 0: Disable 1: Invert
[10]	0x0		Enable SYNC pin synchronization. 0: Disable 1: Enable

Address: 0x465		RW	Default: 0x0004
[2:0]	0x4		Output data interleaver. 0: pass through, no interleaving 1: pass through, channels swapped, no interleaving 2: N/A 3: N/A 4: parallel ADC_A/ADC_B interleaving 5: parallel ADC_B/ADC_A interleaving 6: even-odd interleaving 7: odd-even interleaving

Address: 0x467		RW	Default: 0x2851
[0]	0x1		LVDS enable. 0: Disable 1: Enable
[1]	0x0		LVDS reduced swing mode. 0: Disable 1: Enable
[10:2]	0x14		Reserved.
[13:11]	0x5		LVDS amplitude. 0: Smallest amplitude 0: ... 7: Largest amplitude
[15:14]	0x0		Reserved.

Address: 0x473		RW	Default: 0x0000
[4:0]	0x0		Reserved.
[9:5]	0x0		Output data delay in parallel CMOS mode. The output data delay is increased by 250ps * (register value) with respect to the clock
[13:10]	0x0		Reserved.
[14]	0x0		Output data sending clock polarity in parallel CMOS mode. 0: Not inverted 1: Inverted
[13:10]	0x0		Output clock delay. The output clock delay is increased by 250ps * (register value) with respect to the data
[14]	0x0		Output clock polarity. 0: Not inverted 1: Inverted

Address: 0x475		RW	Default: 0x0001
[0]	0x1		Enable VCM. 0: Disable 1: Enable

Address: 0x477		RW	Default: 0x0000
[1:0]	0x0		Sample delay for ADC A data
[3:2]	0x0		Sample delay for ADC B data

Address: 0x4b5		RW	Default: 0x18c0
[1:0]	0x0		Output format. 0: Offset binary 1: Two's complement 2: Gray code 3: Offset binary
[5:2]	0x0		Output test mode select (see Table 23).
[6]	0x1		Output test channel CH. A 0: Disable 1: Enable
[7]	0x1		Output test channel CH. B 0: Disable 1: Enable
[8]	0x0		Output test toggle mode. Toggle between user test pattern 0 and 1.
[10:9]	0x0		Reserved.
[11]	0x1		PN9 generator reset (active low).
[12]	0x1		PN23 generator reset (active low).
[13]	0x0		Enable the output data scrambler. 0: Disable 1: Enable
[14]	0x0		Enable alternate bit polarity switch. 0: Disable 1: Enable

Address: 0x4b7		RW	Default: 0x0092
[15:0]	0x0092		PN9 initial seed.

Address: 0x4b9		RW	Default: 0x3aff
[15:0]	0x3aff	PN23 initial seed.	
Address: 0x4bb		RW	Default: 0x0000
[15:0]	0x0000	User test pattern 0 (CH. A).	
Address: 0x4bd		RW	Default: 0x0000
[15:0]	0x0000	User test pattern 1 (CH. A).	
Address: 0x4bf		RW	Default: 0x0000
[15:0]	0x0000	User test pattern 0 (CH. B).	
Address: 0x4c1		RW	Default: 0x0000
[15:0]	0x0000	User test pattern 1 (CH. B).	
Address: 0x4c9		RW	Default: 0x0000
[0]	0x0	Disable auto-recalibration. 0: Disable 1: Enable	
[15:1]	0x0	Reserved.	
Address: 0x4cd		RW	Default: 0x0000
[6:0]	0x0	Reserved.	
[7]	0x0	Enable IQ indicator (Digital IOs). 0: Disable 1: Enable	
[15:8]	0x0	Reserved.	
Address: 0x4cf		RW	Default: 0x0035
[14:0]	0x35	Reserved.	
[15]	0x0	Disable production test mode. 0: Test mode enabled 1: Test mode disabled	
Address: 0x4d3		RW	Default: 0x0007
[3:0]	0x7	LVDS common mode voltage.	
[7:4]	0x0	Reserved.	
Address: 0x4fd		RO	Default: N/A
[2:0]		Chip revision.	
[6:3]		Label ID.	
[8:7]		Reserved.	
[10:9]		Resolution ID for device 0: 10-bit 1: 12-bit 2: 14-bit 3: 16-bit	
[13:11]		Speed ID for device.	

Address: 0x4ff	RO	Default: N/A
[0]		Reserved.
[1]		Analog Supply Ready. 0: Not ready 1: Ready
[2]		Digital Supply Ready.
[3]		I/O Supply Ready. 0: Not ready 1: Ready
[4]		Reserved.
[5]		SPI enabled. 0: Not enabled 1: Enabled
[6]		Power down pin status. 0: Inactive 1: Active
[9:7]		Reserved.

0xF00 - ADC_DUAL

Address: 0x809	RW	Default: 0x1800
[11:0]	0x800	A/Q channel gain. 0x000: 0.0 0x800: 1.0 0xfff: 2.0
[12]	0x1	Enable A/Q path gain and offset.

Address: 0x80b	RW	Default: 0x1800
[11:0]	0x800	B/I channel gain. 0x000: 0.0 0x800: 1.0 0xfff: 2.0
[12]	0x1	Enable B/I path gain and offset.

Address: 0x80d	RW	Default: 0x0000
[15:0]	0x0000	A/Q channel offset. Signed 16-bit two's complement number.

Address: 0x80f	RW	Default: 0x0000
[15:0]	0x0000	B/I channel offset. Signed 16-bit two's complement number.

Address: 0xf03		RW	Default: 0x07f9
[0]	0x1		Enable top level bias. 0: Disable 1: Enable
[2:1]	0x0		Reserved.
[3]	0x1		ADC_B enable. 0: Disable 1: Enable
[4]	0x1		ADC_A enable. 0: Disable 1: Enable
[10:5]	0x3f		Mask for enable pin.
Address: 0xf05		RW	Default: 0x0030
[5:0]	0x30		Mask for stand-by pin.
[6]	0x0		Stand-by ADC_B. 0: Disable 1: Enable
[7]	0x0		Stand-by ADC_A. 0: Disable 1: Enable
Address: 0xf07		RW	Default: 0x0043
[0]	0x1		Digital clock enable. 0: Disable 1: Enable
[1]	0x1		Analog clock enable. 0: Disable 1: Enable
[2]	0x0		Reserved.
[3]	0x0		Clock source select. 0: ADC_B 1: ADC_A
[5:4]	0x0		Reserved.
[6]	0x1		ADC clock generator reset (active low).
[7]	0x0		Reserved.
Address: 0xf09		RW	Default: 0x0040
[2:0]	0x0		Channel B source. 000: ADC B (default) 011: ADC A 111: (ADC A + ADC B)/2
[5:3]	0x0		Channel A source. 000: ADC A (default) 011: ADC B 111: 0
[6]	0x1		Reserved.

Address: 0xf0f		RW	Default: 0x0028
[1:0]	0x0		Clock divider (see Interleave and Decimate Mode. 0: Bypass 1: Divide-by-2 2: N/A 3: N/A
[5:2]	0xa		Reserved.

Address: 0xf11		RW	Default: 0x000b
[2:0]	0x3		Reserved.
[4:3]	0x1		VCM voltage control. 0: Lowest common-mode voltage ... 3: Highest common-mode voltage

0xDC0 - ADC A

Address: 0xdc1		RW	Default: 0xbfff
[3:0]	0xf		Reserved.
[4]	0x1		Calibration soft reset (active low).
[15:5]	0x5f9		Reserved.

Address: 0xdc9		RW	Default: 0x06a5
[8:0]	0xa5		Reserved.
[9]	0x1		Stg1 enable background mode.
[11:10]	0x1		Reserved.

Address: 0xdcd		RW	Default: 0x1483
[2:0]	0x3		Stg1 calibration convergence speed in foreground mode (see Table 19).
[11:3]	0x90		Reserved.
[13:12]	0x1		Stg1 calibration randomization sequence in foreground mode (see Table 19).

Address: 0xdcf		RW	Default: 0x0d85
[2:0]	0x5		Stg1 calibration convergence speed in background mode (see Table 19).
[11:3]	0x1b0		Reserved.

Address: 0xdd1		RW	Default: 0x02a5
[0]	0x1		Stage 2 gain error calibration enable.
[1]	0x0		Stage 2 gain error calibration only.
[8:2]	0x29		Reserved.
[9]	0x1		Stg2 enable background mode.
[11:10]	0x0		Reserved.

Address: 0xdd3		RW	Default: 0x0bc0
[0]	0x0		Stg2 force calibration data.
[3:1]	0x0		Stg2 calibration data register.
[6:4]	0x4		Stg2 bg calibration data register.
[9:7]	0x7		Stg2 fg calibration data register.
[11:10]	0x2		Stg2 calibration mode.
[14:12]	0x0		Stg2 capacitor select register.
[15]	0x0		Stg2 cal data magnitude.

Address: 0xdd5		RW	Default: 0x1483
[2:0]	0x3		Stg2 calibration convergence speed in foreground mode (see Table 19).
[11:3]	0x90		Reserved.
[13:12]	0x1		Stg2 calibration randomization sequence in foreground mode (see Table 19).

Address: 0xdd7		RW	Default: 0x0001
[2:0]	0x1		Stg2 calibration convergence speed in background mode (see Table 19).
[11:3]	0x0		Reserved.

Address: 0xddd		RW	Default: 0x16c3
[2:0]	0x3		Stg3 calibration convergence speed in foreground mode (see Table 19).
[11:3]	0xd8		Reserved.
[13:12]	0x1		Stg3 calibration randomization sequence in foreground mode (see Table 19).

Address: 0xde1		RW	Default: 0xbbe8
[7:0]	0xe8		Time allocated for calibration (see Table 19).
[8]	0x1		Enable calibration (see Table 19).
[9]	0x1		Enable foreground calibration (see Table 19).
[10]	0x0		Reserved.
[11]	0x1		Enable stg1 calibration (see Table 19).
[12]	0x1		Enable stg2 calibration (see Table 19).
[13]	0x1		Enable stg3 calibration (see Table 19).
[14]	0x0		Background calibration parallel mode (see Table 19).
[15]	0x1		Disable background calibration mode for all stages (see Table 19).

Address: 0xde3		RW	Default: 0x0008
[2:0]	0x0		Reserved.
[3]	0x1		Clipping control to reserve some headroom for background calibration signals (active low).

Address: 0xde7		RW	Default: 0x0004
[2:0]	0x4		Reserved.
[4:3]	0x0		Output data timing. (see Interleave and Decimate Mode)

Address: 0xdeb		RW	Default: 0x0000
[0]	0x0		Calibration status. 0: Not done 1: Done
[7:1]	0x0		Reserved.

Address: 0xdef	RO	Default: N/A
[0]		Calibration complete.
[15:1]		Reserved.

0xCC1 - ADC B

Address: 0xcc1	RW	Default: 0xbfff
[3:0]	0xf	Reserved.
[4]	0x1	Calibration soft reset (active low).
[15:5]	0x5f9	Reserved.

Address: 0xcc3	RW	Default: 0x0000
[3:0]	0x0	Clock phase. (see Interleave and Decimate Mode)
[14:4]	0x0	Reserved.

Address: 0xcc9	RW	Default: 0x06a5
[8:0]	0xa5	Reserved.
[9]	0x1	Stg1 enable background mode.
[11:10]	0x1	Reserved.

Address: 0xccd	RW	Default: 0x1483
[2:0]	0x3	Stg1 calibration convergence speed in foreground mode (see Table 19).
[11:3]	0x90	Reserved.
[13:12]	0x1	Stg1 calibration randomization sequence in foreground mode (see Table 19).

Address: 0xccf	RW	Default: 0x0d85
[2:0]	0x5	Stg1 calibration convergence speed in background mode (see Table 19).
[11:3]	0x1b0	Reserved.

Address: 0xcd1	RW	Default: 0x02a5
[0]	0x1	Stage 2 gain error calibration enable.
[1]	0x0	Stage 2 gain error calibration only.
[8:2]	0x29	Reserved.
[9]	0x1	Stg2 enable background mode.
[11:10]	0x0	Reserved.

Address: 0xcd5	RW	Default: 0x1483
[2:0]	0x3	Stg2 calibration convergence speed in foreground mode (see Table 19).
[11:3]	0x90	Reserved.
[13:12]	0x1	Stg2 calibration randomization sequence in foreground mode (see Table 19).

Address: 0xcd7	RW	Default: 0x0001
[2:0]	0x1	Stg2 calibration convergence speed in background mode (see Table 19).
[11:3]	0x0	Reserved.

Address: 0xcdd	RW	Default: 0x16c3
[2:0]	0x3	Stg3 calibration convergence speed in foreground mode (see Table 19).
[11:3]	0xd8	Reserved.
[13:12]	0x1	Stg3 calibration randomization sequence in foreground mode (see Table 19).

Address: 0xce1		RW	Default: 0xbbe8
[7:0]	0xe8		Time allocated for calibration (see Table 19).
[8]	0x1		Enable calibration (see Table 19).
[9]	0x1		Enable foreground calibration (see Table 19).
[10]	0x0		Reserved.
[11]	0x1		Enable stg1 calibration (see Table 19).
[12]	0x1		Enable stg2 calibration (see Table 19).
[13]	0x1		Enable stg3 calibration (see Table 19).
[14]	0x0		Background calibration parallel mode (see Table 19).
[15]	0x1		Disable background calibration mode for all stages (see Table 19).

Address: 0xce3		RW	Default: 0x0008
[2:0]	0x0		Reserved.
[3]	0x1		Clipping control to reserve some headroom for background calibration signals (active low).

Address: 0xceb		RW	Default: 0x0000
[0]	0x0		Calibration status. 0: Not done 1: Done
[7:1]	0x0		Reserved.

Address: 0xcef		RO	Default: N/A
[0]			Calibration complete.
[15:1]			Reserved.

0x800 - ADC_DSP

Address: 0x805		RW	Default: 0x0000
[1:0]	0x0		DSP Output clock divider: 00: Disabled (default) 01: Divide by 2 10: Divide by 4 11: N/A

Address: 0x807		RW	Default: 0x0300
[0]	0x0		Interleaving Control.
[6:1]	0x0		Reserved.
[7]	0x0		Bypass gain correction. 0: Include gain correction 1: Bypass gain correction
[8]	0x1		Bypass phase correction. 0: Include phase correction 1: Bypass phase correction
[9]	0x1		Bypass digital down converter (DDC). 0: Include DDC 1: Bypass DDC
[10]	0x0		Swap I and Q channels. 0: No swap 1: Swap
[12:11]	0x0		A/Q data delay.
[14:13]	0x0		B/I data delay.
Address: 0x811		RW	Default: 0x0000
[9:0]	0x0		IQ phase correction. Signed 10-bit two's complement number. Valid range from -511 to +511.
[10]	0x0		Enable IQ phase correction. 0: Disable 1: Enable

Address: 0x813		RW	Default: 0x12a8
[0]	0x0		Enable DDC Q path. 0: Disable 1: Enable
[1]	0x0		Enable DDC I path. 0: Disable 1: Enable
[3:2]	0x2		LO1 select: 0: Disabled 1: DDS1 2: DDS2 3: N/A
[5:4]	0x2		LO2 select: 0: Disabled 1: DDS1 2: DDS2 3: N/A
[6]	0x0		Low power mode. 0: Disable 1: Enable
[7]	0x1		LO in low power mode: 0: fs/4 1: fs/2
[11:8]	0x2		IQ sum signs: 0: I*sin 1: Q*cos 2: Q*sin 3: I*cos
[12]	0x1		IQ sum gain: 0: 1.0 1: 0.75
[14:13]	0x0		Output data select: 0: bypass 1: I and Q 2: IQ sum 3: LO

Address: 0x815		RW	Default: 0x0000
----------------	--	----	-----------------

[15:0]	0x0000		DDS1 frequency: bits 15:0.
--------	--------	--	----------------------------

Address: 0x817		RW	Default: 0x0000
----------------	--	----	-----------------

[15:0]	0x0000		DDS1 frequency: bits 31:16.
--------	--------	--	-----------------------------

Address: 0x819		RW	Default: 0x0000
----------------	--	----	-----------------

[15:0]	0x0000		DDS1 frequency: bits 47:32.
--------	--------	--	-----------------------------

Address: 0x81b		RW	Default: 0x0000
----------------	--	----	-----------------

[15:0]	0x0000		DDS2 frequency: bits 15:0.
--------	--------	--	----------------------------

Address: 0x81d		RW	Default: 0x0000
----------------	--	----	-----------------

[15:0]	0x0000		DDS2 frequency: bits 31:16.
--------	--------	--	-----------------------------

Address: 0x81f		RW	Default: 0x0000
[15:0]	0x0000		DDS2 frequency: bits 47:32.
Address: 0x821		RW	Default: 0x0000
[15:0]	0x0000		DDS1 phase offset. Signed 16-bit two's complement number.
Address: 0x823		RW	Default: 0x0000
[15:0]	0x0000		DDS2 phase offset. Signed 16-bit two's complement number.
Address: 0x825		RW	Default: 0x0010
[5:0]	0x10		DDS1 sine amplitude. Signed 6-bit two's complement number.
Address: 0x827		RW	Default: 0x0000
[5:0]	0x0		DDS1 sine offset. Signed 6-bit two's complement number.
[11:6]	0x0		DDS1 cosine offset. Signed 6-bit two's complement number.
Address: 0x829		RW	Default: 0x0000
[5:0]	0x0		DDS2 sine offset. Signed 6-bit two's complement number.
[11:6]	0x0		DDS2 cosine offset. Signed 6-bit two's complement number.
[12]	0x0		DDS phase dither enable. 0: Disable 1: Enable
[13]	0x0		DDS amplitude dither enable. 0: Disable 1: Enable
Address: 0x82b		RW	Default: 0x0000
[0]	0x0		Load DDS1 frequency. Toggle to load DDS1 frequency.
[1]	0x0		Load DDS2 frequency. Toggle to load DDS2 frequency.
[2]	0x0		Load DDS1 phase. Toggle to load DDS1 phase offset.
[3]	0x0		Load DDS2 phase. Toggle to load DDS2 phase offset.
[5:4]	0x0		DDS mode: 0: sine 1: saw tooth 2: triangle 3: phase
Address: 0x82d		RW	Default: 0x0130
[3:0]	0x0		Reserved.
[5:4]	0x3		Decimator pulse rate: 0: 1 1: 1/2 2: 1/4 3: N/A
[8:6]	0x4		Reserved.

Address: 0x82f		RW	Default: 0x0147
[0]	0x1		Bypass decimator. 0: Do not bypass 1: Bypass
[1]	0x1		Enable decimator input path A. 0: Disable 1: Enable
[2]	0x1		Enable decimator input path B. 0: Disable 1: Enable
[3]	0x0		Enable decimator path C. 0: Disable 1: Enable
[5:4]	0x0		Decimation factor: 0: 2x 1: 2x, interleaved ADC 2: 4x 3: 4x, interleaved ADC
[7:6]	0x1		Filter 1 gain: 0: 1.0 1: 0.75 2: 0.5 3: 0.25
[9:8]	0x1		Filter 2 gain: 0: 1.0 1: 0.75 2: 0.5 3: 0.25

REVISION HISTORY

Version	Date	Comment
1.0	January 20, 2026	Initial Release.

Silanna Semiconductor Proprietary and Confidential

Information furnished by Silanna Semiconductor is believed to be accurate and reliable. However, no responsibility is assumed for its use. Silanna Semiconductor makes no representation that the interconnection of its circuits as described herein will not infringe on existing patents rights. Specifications subject to change without notice.

Preliminary